



ECO_B
ILLUMINATION
Catalogue VOL.04



CONTENTS

In-ground luminaires NAUTILUS SQ, NAUTILUS BT, NAU-TL, NAU-SPOT	13
Beacon luminaires VISION, FLAT, DECK CAP LIGHT, ECO-STL	23
Bollards PP20, PP20-EX, WOODY, STEM, STEM-TREE HEXAGON, CUBO, CUTEM, GRID DAON-CUSTOM, DAON-ROUND, DAON-SHADE WIDER, STAMP, ECO-B001 ECO-B002, ECO-B003, ECO-B004	33
Linear luminaires FLEX, FREEBEND, S-MONO, S-TUNEABLEWHITE, ECO-SIDE	71
Floodlights CANON, CANON-S, PORT FOREST, ECO-F40, ECO-F75, ECO-F15, ECO-F25 WRINKLE2, HORUS, FREEBEND TREE, PEAK, PEAK360	81
Pole luminaires FL35, PL40, PLM40 VERTICAL4000, PL101, PL102 WRINLE MP, MP190 SL-40,BL-40, PL-70N, PL-190B	105
Sites	132



PRODUCT LIST

In-ground luminaires



Nautilus-SQ / P.15

Nautilus-BT / P.17



NAU-TL / P.19

NAU-SPOT / P.21

Beacon luminaires



VISION / P.25

FLAT / P.27



ECO-STL / P.29

DECK CAP LIGHT / P.31

Bollards



PP20 / P.35

PP20-EX / P.37

WOODY / P.39

STEM / P.41

STEM-TREE / P.43



HEXAGON / P.45

CUBO / P.47

CUTEM / P.49

GRID / P.51

DAON-CUSTOM / P.53



DAON-ROUND / P.55

DAON-SHADE / P.57

WIDER / P.59

STAMP / P.61

ECO-B001 / P.63

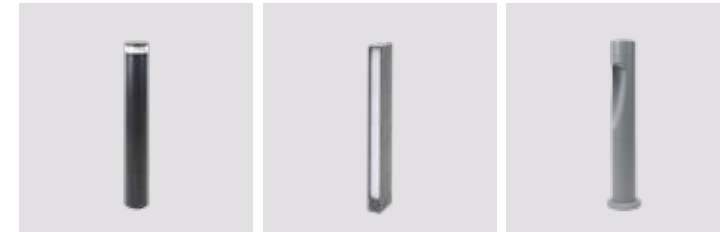

ECO-B002 / P.65

ECO-B003 / P.67

ECO-B004 / P.69

Linear luminaires



FLEX / P.73

FREEBEND / P.75

S-MONO, TW / P.77

ECO-SIDE / P.79

Floodlights

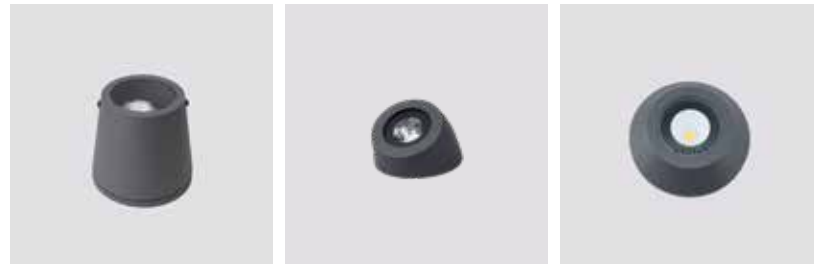

CANON / P.83

CANON-S / P.85

PORT / P.87



ECO-FOREST / P.89

ECO-F40,F75 / P.91

ECO-F15,F25 / P.93

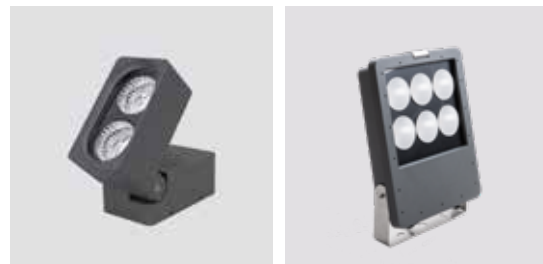

WRINKLE 2 / P.95

HORUS / P.97



FREEBEND TREE / P.99

PEAK / P.101

PEAK-360 / P.103

Products list available VOL.04

Pole luminaires

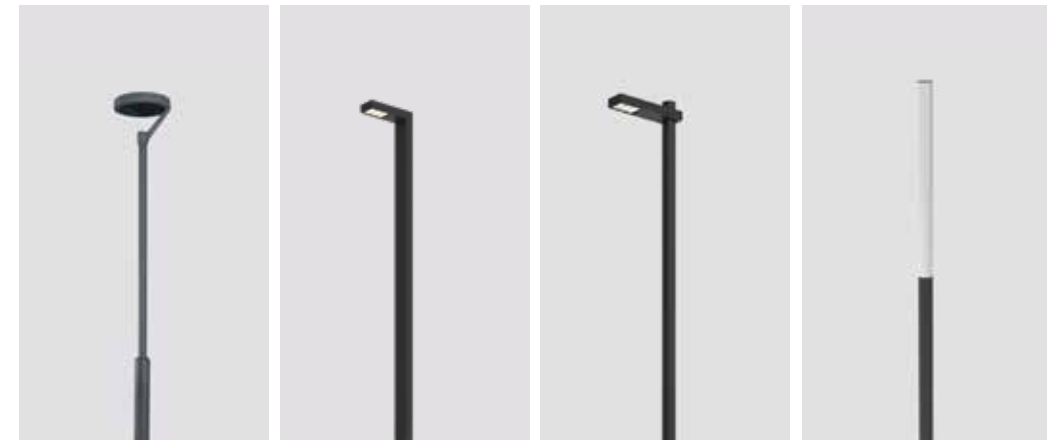

FL35 / P.107

PL40 / P.109

PLM40 / P.111

VERTICAL4000 / P.113



ECO-PL101 / P.115

ECO-PL102 / P.117

WRINKLE MP / P.119

MP190 / P.121



SL-40 / P.125

BL-40 / P.127

PL-70N / P.129

PL-190B / P.131



In-ground luminaires
aesthetic and stable lights

NAUTILUS-SQ

Drive-over in-ground luminaires



노틸러스 SQ는 기계적 강도 및 내구성이 매우 우수한 제품이며, 설치시 하자율이 매우 적습니다. 3개 열의 LED 모듈 조합은 개별 배광 및 각도 조절이 가능합니다. 이는 처마가 긴 전통 건축물이나 조형물과 같이 입체적인 대상물에 빛의 연출이 자유로운 특징을 가지고 있습니다. 아울러, 일반적인 지중등과 비교하여 눈부심이 적은 제품입니다.

Nautilus-sq is a product specially designed for traditional architecture. It has 3 independently tiltable Led modules which can apply a variety of Lens. It is optimized for its aiming for traditional architecture and has been supplied to national heritage such as Chang-deuk place, Gyeong-bok Place.

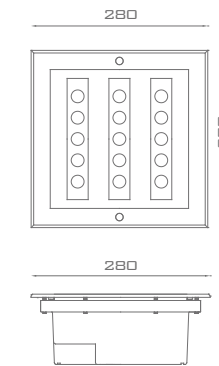
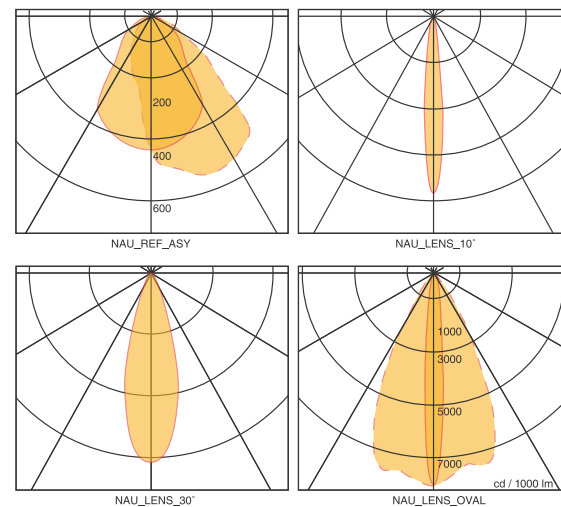

NAUTILUS-SQ

프레임 링구는 스테인레스 스틸로 제작되었습니다.
 제품의 하우징은 고강도 주조 알루미늄으로 고 하중(2,800kg) 압력을 견딜 수 있습니다.
 강화유리 적용(투명유리, 샌딩유리) 반사판 적용한 투광 타입 각각의 광원 모듈은 각도 조절이 가능합니다.
 모듈별로 0°에서 20° 조절이 가능합니다.

Frame ring is made of stainless steel
 Luminaires housing is made of High strength cast aluminium which endures high pressure and heavy weight(2,800kg)
 Safety glass(clear type, sanding type optional)
 Floodlights with reflector.

Each modules are adjustable, each module can rotate easily from 0 to 20 degree.

Lens option : 10°, 20°, 30°, Oval , ASY
 Finish color : Hairline, Black, on demand.



ECO SMART LOUVRE SYSTEM
 글레이 차단 시스템 적용가능
 (보행 시야각 글레이 95% 차단)



LENS VARIATION - 10°, 20°, 30°, Oval, ASY

- COVER : Stainless steel
- BODY : Aluminium die-casting
- SIZE : W280 x L280 x H110
- CRI : ≤80 (option ≤90)
- Lamp : LED 36W
- IV : Constant Current
Constant Voltage
- CT : 3000K, 4000K



NAUTILUS-BT

Drive-over in-ground luminaires
compact type with COB and Reflector

노틸러스BT 컴팩트한 타입의 원형 지중등입니다.

제품에는 AC COB가 적용되어 있고, 다양한 렌즈군을 장착할 수 있습니다. 현장 여건에 적합한 반사판 및 렌즈를 적용하여, 요구하는 연출에 최적화되어있습니다. 또한 고신뢰성의 LED 제품과 유지보수가 쉬운 특징점이 있습니다.

Nautilus-BT is a compact type circular in-ground luminaires. It has a sole COB which can be combined with a variety of LENS and reflector. It is also easy for long-term maintenance.

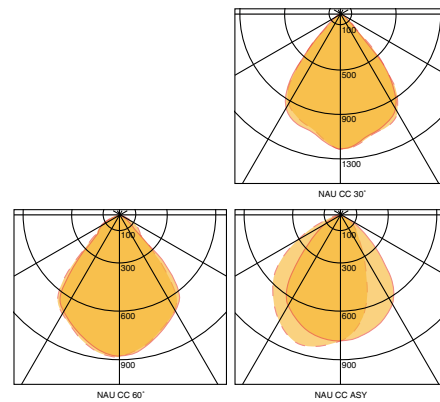

ASSY. Type



360. Type

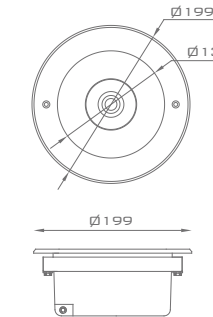

NAUTILUS-BT

프레임 링구는 스테인레스 스틸로 제작되었습니다.
제품의 하우징은 고강도 주조 알루미늄으로
고 하중(2,000 kg)과 압력을 견딜 수 있습니다.
강화유리 적용(투명유리, 샌딩유리)
단일 AC TYPE COB(10W, 20W)

렌즈 옵션 : 30°, 60°, ASY
글레어컨트롤 필터 적용가능

Frame ring is made of stainless steel
Luminaires housing is made of High strength
cast aluminum which endures high pressure
and heavy weight(2,800 kg)
Safety glass(clear type, sanding type optional)
AC TYPE COB(10W, 20W)

Lens option : 30°, 60°, ASY
Finish color : Hairline, Black, on demand.

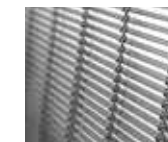

ECO SMART LOUVRE SYSTEM
글레어 차단 시스템 적용가능
(보통 시야각 글레어 95% 차단)

COVER : Stainless steel
BODY : Aluminium die-casting
SIZE : ø199 x H84
CRI : ≤90 (option ≤97)
Lamp : LED 10W, 20W
I V : AC Drive
C T : 3000K, 4000K



NAU-TL

Circular type
Drive-over Swivel in-ground luminaires



NAU-TL은 원형 지중등으로써, 기계적 강도 및 내구성이 우수하며, 지중등 제품에 적합한 내구성과 방수등급을 가지고 있습니다. 제품 외부에서 내부 광원부 에이밍이 가능하여 조경 현장에서 다양한 연출효과를 구현할 수 있습니다.

The NAU-TL has excellent mechanical strength and durability, making it ideal for use in-ground lighting applications. It features a robust design and a high waterproof rating, ensuring suitability for outdoor environments. The light source can be aimed externally, enabling versatile lighting effects for landscape projects.

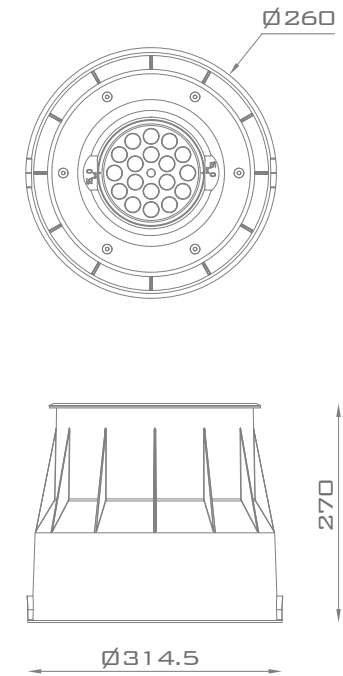
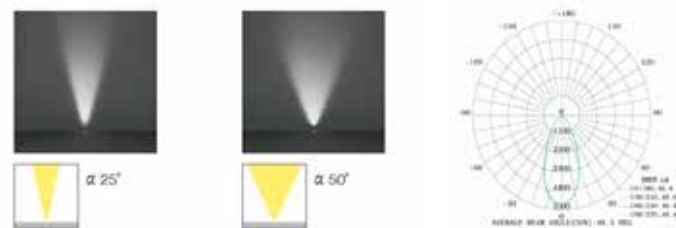

NAU-TL

프레임 링구는 스테인레스 스틸로 제작되었습니다.
제품의 하우징은 다이캐스팅 알루미늄으로 고하중(2,000 kg)과 압력을 견딜 수 있습니다. 강화유리 적용(투명유리, 샌딩유리)

25°, 50° 등 다양한 타입의 렌즈 적용이 가능합니다.

Frame ring is made of stainless steel
Luminaires housing is made of Die-cast aluminum which endures high pressure and heavy weight(2,000 kg)
Safety glass(clear type, sanding type optional)

Lens for floodlights are adjustable.
Lens option : 25°, 50°
Finish color : Hairline

*제품 세부 치수 및 하우징 사양 등에 대해서는 적용 전 협의바랍니다.



제품 내부 회전 모듈을 하부에서 조절 에이밍 가능

COVER : Stainless steel
BODY : Aluminium die-casting
SIZE : ø260 x H144 (Housing : ø314.5)
CRI : ≤80,90
Lamp : LED 25W, 40W
I V : AC 100-240V / DC 24V
C T : 3000K,4000K

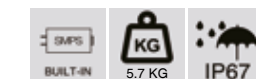

NAU-SPOT

Circular type
SPOT in-ground luminaires



NAU-SPOT은 컴팩트한 타입의 원형 스폿 지중등입니다. 현장 여건에 적합한 다양한 렌즈 구성을 제공하며 글레어를 방지하는 하이브리드 렌즈 기술이 적용되어 다양한 현장에서 매우 활용도가 높은 제품입니다.

Nau-SPOT is a compact type circular spot in-ground luminaires. It offers a variety of lens configurations to suit site conditions and incorporates advanced lens technology to minimize glare. This versatile product is highly adaptable to a wide range of applications.

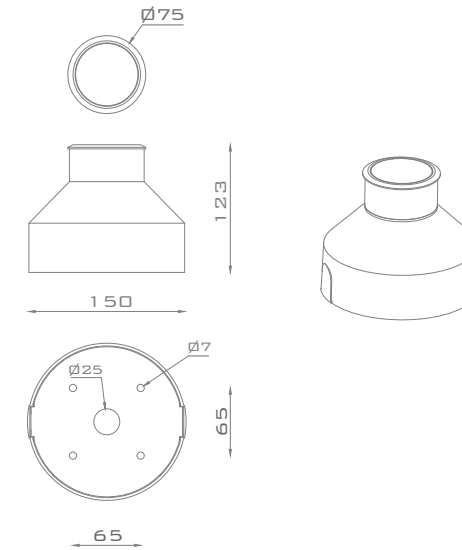

NAU-SPOT

프레임 링구는 스테인레스 스틸로 제작되었습니다.
제품바디는 다이캐스팅 알루미늄으로 고하중(2,000 kg)과 압력을 견딜 수 있습니다. 강화유리 적용(투명유리, 샌딩유리)

15°, 30°, 50°, 비대칭, 확산 등 다양한 타입의 렌즈 적용이 가능합니다.

Frame ring is made of stainless steel
Luminaires' body is made of Die-cast aluminum which endures high pressure and heavy weight(2,000 kg)
Safety glass(clear type, sanding type optional)

Lens for floodlights are adjustable.
Lens option : ASY, 15°, 30°, 50°, Frosted
Finish color : Hairline

COVER : Stainless steel
BODY : Aluminium die-casting
SIZE : $\phi 75 \times H123$ (Housing : $\phi 150$)
CRI : $\leq 80, 90$
Lamp : LED 6W
I V : Constant Voltage
C T : 3000K, 4000K

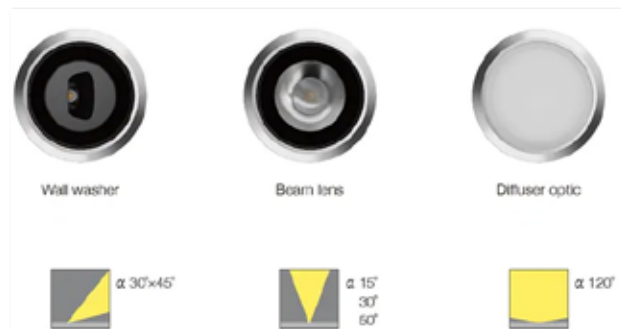



Beacon luminaires
Lights for steps, pathways, garden

VISION

Beacon lights
for garden, steps, pathways



VISION 제품은 비컨등으로써, 보행자의 동선을 밝히는 컴팩트한 카메라 형태의 제품입니다. 제품은 정원, 계단, 다리, 보행로, 출렁다리 등. 보행자의 안전을 위한 조도 확보가 필요한 장소에 설치됩니다.

Vision is a compact type beacon light which brights the passage of a pedestrian. The Product can be applied to garden, steps, bridge, pathways and hanging bridge which needs lights for safety reason.

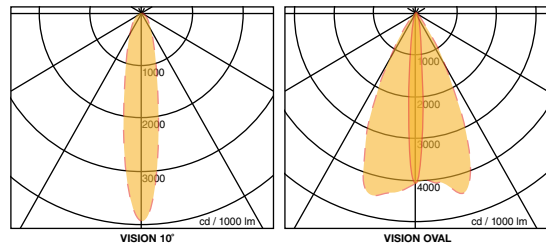

VISION

제품의 하우징은 알루미늄으로 제작되었습니다.
강화유리 적용(투명유리, 실크스크린)
렌즈부 교체가능(10°, 30°, 60°, OVAL 타입 렌즈)
허니컴루버, 외함형 루버, 틸트형 브라켓 장착가능.

Luminaires housing made of aluminum.
Safety glass(clear type, silk screen)
Floodlights with reflector(10°,30°,60°,OVAL)

Accessories applicable : Honeycomb, Louver,
Adjustable bracket.

Lens option : 10°, Oval

Finish color : Dark Brown, Dark Grey, on demand.

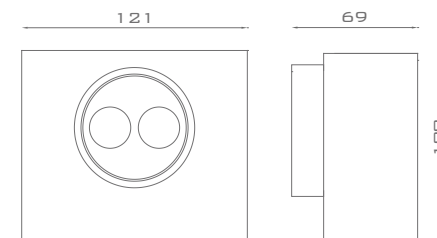

BODY : Aluminium die-casting
SIZE : W121 x L69 x H100
CRI : ≤80
Lamp : LED 6W
I V : Constant Current
C T : 3000K

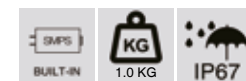

FLAT

Surface mounted on-ground luminaires



FLAT은 새로운 형태의 기구로 기존 지중등의 단점을 보완한 제품으로 설치방법이 기존 지중(In-ground)에서 지면(Surface)으로 끌어올려 배수 문제로 인한 하자를 방지하였으며, 습기에 의한 결로 현상을 획기적으로 줄였습니다.

FLAT is new type luminaires, which supplement prior type In-ground luminaires. It is installed in Surface, and it can prevent defect from drainage problem, and it overcomes condensation problem.

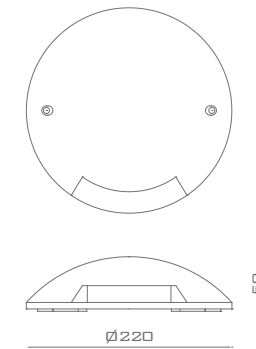
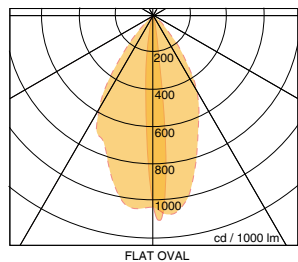

FLAT

제품의 하우징 및 바디는 알루미늄으로 제작되었습니다.
강화유리 적용(투명유리)

전원 선의 기구 내부 인입 시 별도의 레진 방수실을 만들어
기구 내부 침수를 방어하며, 전자부품을 보호합니다.

Oval 렌즈를 적용한 투광 타입

Body and luminaires housing made of die-casted
Aluminum Safety glass(Clear type)

Waterproof by resin partition inside the housing
which Can protect electrical parts.

Floodlights with Oval Lens

Finish color : Black, Dark brown, Dark grey, On demand

BODY : Aluminium die-casting
SIZE : $\varnothing 220 \times H59$
CRI : ≤ 80
Lamp : LED 6W
I V : Constant Current
C T : 3000K

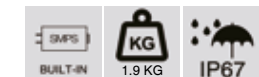

ECO-STL

Beacon lights
for garden, steps, pathways



ECO-STL 제품은 비컨등으로써, 보행자의 동선을 밝히는 작고 유려한 형태의 스텝등 제품입니다. 제품의 특성상 글레어가 거의 발생하지 않아 쾌적한 환경이 필요로하는 공간에 적합합니다. 제품은 정원, 계단, 다리, 보행로, 벽체 등. 보행자의 안전을 위한 조도 확보가 필요한 장소에 설치됩니다.

ECO-STL is a compact and flat type beacon light which brights the passage of a pedestrian.
Due to the structure of the product, glare is almost removed and It is suitable for spaces that require a pleasant environment.
The Product can be applied to garden,steps, bridge, pathways and hanging bridge which needs lights for safety reason.

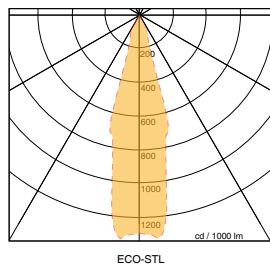

ECO-STL

제품의 하우징은 스테인레스틸로 제작되었습니다.
폴리카보네이트 적용
렌즈없는 확산타입(디퓨져적용 가능)
베이스 형태 변형 및 팩타입으로 적용 가능.

Luminaires housing made of stainless steel.
Polycarbonate Diffuser applicable(for softer light)

Accessories applicable : Base, Pack type

Finish color : Dark Brown, Dark Grey, on demand.

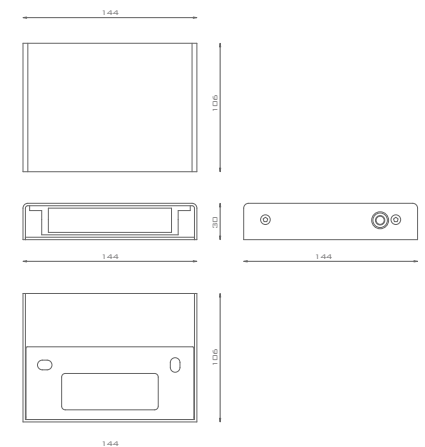

BODY : Stainless steel
SIZE : W144 x L106 x H30
CRI : ≤80
Lamp : LED 5W(DC 24V 컨버터외장형)
I V : Constant voltage
C T : 3000K



ECO-DECK CAP LIGHT

DECK POST CAP LIGHTING
for Deck, park, garden



ECO-DECK CAP LIGHT 제품은 데크기둥의 상부캡을 대신하여 설치되는 제품입니다.
보행자의 안전조도를 안정적으로 확보하는 동시에, 아름다운 데크조명 연출을 가능하게합니다.
아울러, 데크조명에 부착되는 불필요한 덕트와 브라켓이 필요하지 않아, 데크시설물 본래의 디자인에 최소한의 변형이 필요로하는 공간에 적합합니다.

ECO-DECK CAPLIGHT products are installed in place of the upper cap of the deck column.
Since unnecessary ducts and brackets attached to deck lighting are not necessary,
the original purpose and design of deck facilities can be kept.
It is suitable for spaces where a comfortable environment requires minimal intervention.

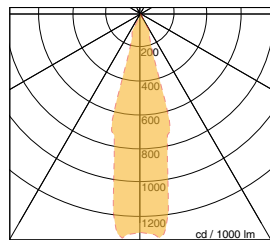

ECO-DECK CAP LIGHT

제품의 하우징은 스테인레스스틸로 제작되었습니다.
폴리카보네이트 적용
렌즈없는 확산타입(디퓨져적용 가능)
데크기둥재 사이즈에 따름(100X100mm, 120X120mm)
Luminaires housing made of stainless steel.
Polycarbonate
Diffuser applicable(for softer light)
Size depends on deck post size(100mm,120mm)
Finish color : Dark Brown, Dark Grey, on demand.

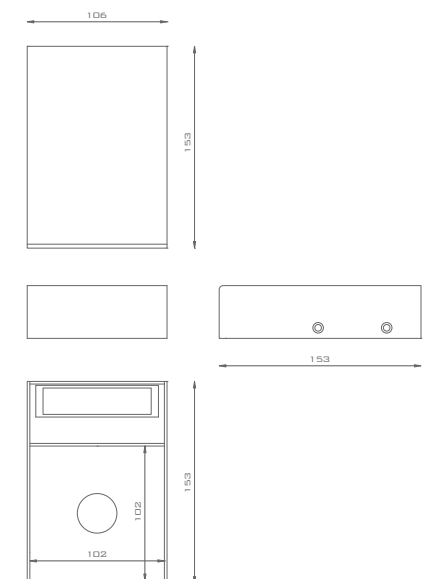

BODY : Stainless steel
SIZE : W153 x L106 x H30
CRI : ≤80
Lamp : LED 5W(DC 24V 컨버터외장형)
I V : Constant voltage
C T : 3000K





Bollards
Eco Design bollards

PP20

Energy-saving and efficient LED bollards for the illumination of ground surfaces.



PP20은 에너지 효율성과 높은 안정성을 지닌 LED 볼라드 제품입니다. 주변 환경과의 조화를 중점적으로 생각하여, 통로 구간 및 건축물, 자연과 위화감 없는 '최소'의 디자인을 구현하였습니다. 공간의 특성에 맞게 플의 높이를 조절하여, 다양한 디자인 구현 또한 가능합니다.

PP20 is energy-efficient and stable LED bollards luminaires. Its design focus mainly on harmony with environments around bollards which minimize the design elements. Dimension of product can be modified.

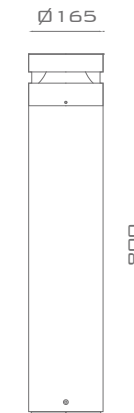
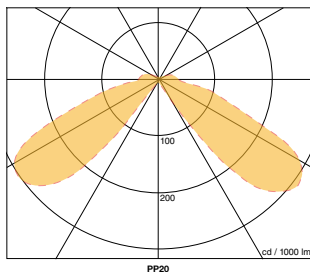

PP20

제품의 바디는 캐스팅 알루미늄 및 스테인레스 스틸로 제작되었습니다. 강화유리 적용(투명 유리) 고효율 LED적용(3000K, 4000K) 현장 여건에 따른 사이즈(H:300, 600, 800)

볼라드 제품은 하부고정 스테인레스 스틸 플레이트와 함께 제공됩니다. 플레이트에 현장 여건에 적합한 양카시공이 요구됩니다.

Luminaires housing made of cast aluminum, stainless steel Safety glass(Clear type)
High effective ECO LED Module(3000K,4000K) Three sizes for the differing dimensions of the installation site.
(H:300,600,800)

Finish color : Dark grey, on demand.

BODY : Cast aluminium
SIZE : $\varnothing 165 \times H800$
CRI : ≤ 90
Lamp : LED 20W
I V : Constant Current
Constant Voltage
C T : 3000K, 4000K



PP20-EX

Energy-saving and efficient LED bollards for the illumination of ground surfaces.



PP20-EX은 에너지 효율성과 높은 안정성을 지닌 LED 볼라드 제품입니다. 주변 환경과의 조화를 중점적으로 생각하여, 통로 구간 및 건축물, 자연과 위화감 없는 '최소'의 디자인을 구현하였습니다. PP20 제품과 다른점으로는, 디퓨저가 노출되지 않는 특성의 제품으로 하부면 그림자의 크기를 줄이고, 부드러운 표면 질감을 표현합니다. 공간의 특성에 맞게 폴의 높이를 조절하여, 다양한 디자인 구현 또한 가능합니다.

PP20-EX is energy-efficient and stable LED bollards luminaires. Its design focus mainly on harmony with environments around bollards which minimize the design elements. Dimension of product can be modified.

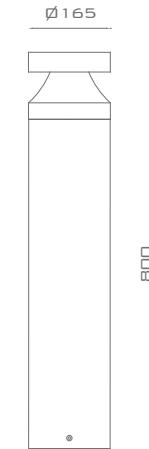
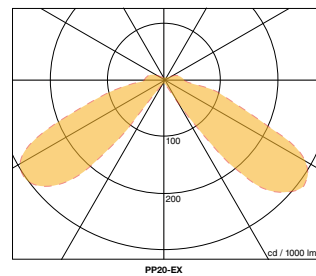

PP20-EX

제품의 바디는 캐스팅 알루미늄 및 스테인레스 스틸로 제작되었습니다. 강화유리 적용(투명 유리) 고효율 LED적용(3000K, 4000K) 현장 여건에 따른 사이즈(H:300, 600, 800)

볼라드 제품은 하부고정 스테인레스 스틸 플레이트와 함께 제공됩니다. 플레이트에 현장 여건에 적합한 양카시공이 요구됩니다.

Luminaires housing made of cast aluminum, stainless steel Safety glass(Clear type)
High effective ECO LED Module(3000K,4000K) Three sizes for the differing dimensions of the installation site.
(H:300,600,800)

Finish color : Dark grey, on demand.

BODY : Cast aluminium
SIZE : \varnothing 165 x H800
CRI : \leq 90
Lamp : LED 20W
I V : Constant Current
Constant Voltage
C T : 3000K, 4000K



WOODY

LED Bollards combined with Rope barriers for pedestrian protection.



WOODY는 문화재 현장의 수목보호 원형 말뚝에서 착안한 제품입니다. 볼라드의 역할을 수행함과 동시에 보행자로부터 수목을 보호합니다. 디자인적으로 역시 통로 구간 및 건축물 자연과의 위화감 없는 '최소'의 디자인을 구현하였습니다. 공간의 특성에 맞게 폴의 높이를 조절하여, 다양한 디자인 구현 또한 가능합니다.

WOODY is derived from plant protection pile located in cultural Heritage site. It works perfectly as bollards and as well as plant protection piles. Its design focuses mainly on harmony with environments around bollards which minimize the design elements. Dimension of product can be modified.

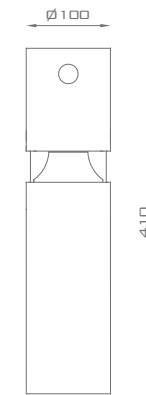
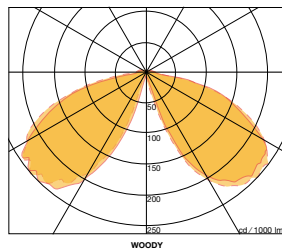

WOODY

제품의 바디는 캐스팅 알루미늄 및 스테인레스 스틸로 제작되었습니다.
강화유리 적용(투명 유리) 고효율 LED 적용(3000K, 4000K)
현장 여건에 따른 사이즈(H:300, 410, 600)

에코브릿지 볼라드 제품은 하부고정 스테인레스 스틸 플레이트와 함께 제공됩니다.
플레이트에 현장여건에 적합한 앙카사공이 요구됩니다.

Luminaires housing made of cast aluminum, stainless steel
Safety glass(Clear type)
High effective ECO LED Module(3000K,4000K)
Three sizes for the differing dimensions of the installation site.
(H:300,410,600)

Finish color : Dark brown, Dark grey, on demand.

BODY : Aluminium die-casting
SIZE : $\Phi 100 \times H410$
CRI : ≤ 90
Lamp : LED 10W
I V : Constant Current
Constant Voltage
C T : 3000K, 4000K

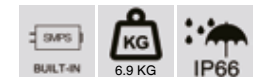

STEM

360 ° luminaires 3-Tier Bollards system.

STEM은 3개의 360도 틸트 가능한 지향형 투광등이 결합된 파이프 구조의 볼라드 제품입니다.

보행자를 위한 스텝등의 역할과 수목을 자유롭게 비출 수 있는 타입으로, 기존의 등 기구가 가지고 있는 연출 제약을 극복한 제품입니다. 현장의 여건에 따라 적층 구조를 늘리거나 줄일 수 있으며, 다양한 연출 제어에 특화된 제품입니다.

STEM is 360 degree tilt-able 3-tier Floodlight module system bollards. It works as a step-light for pedestrian as well as light for trees and garden which overcome the limit of prior aiming method.

Tier system can be added and subtracted depends on the site which maximize the quality of site situation.

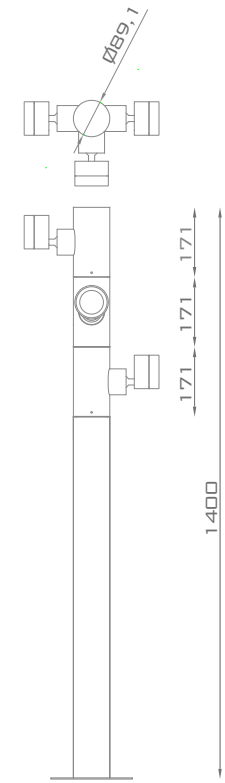

Stem

개별 지향형 투광등은 다이캐스팅 알루미늄으로 제작되었습니다.
제품의 적층 폴은 스테인레스 스틸로 제작되었습니다.
강화유리 적용(투명 유리) 단일 COB 위 렌즈 적용(20°, 60°, Oval)

각각의 광원 부는 각도 조절이 가능합니다.
각 모듈은 손쉽게 상하좌우 조절이 가능합니다.

Each floodlight luminaire is made of aluminum.
Each tier and pole is made of stainless steel.
Safety glass(clear type)
Floodlights with reflector(20°, 60°, Oval)

Each floodlight are adjustable, each module can rotate freely 360°.

Finish color : Dark grey, on demand.

BODY : Aluminium die-casting
POLE : Stainless steel
SIZE : W335 x L335 x H1400
CRI : ≤90
Lamp : LED 10W / 15W / 20W
I V : Constant Current / AC Drive
C T : 3000K, 4000K

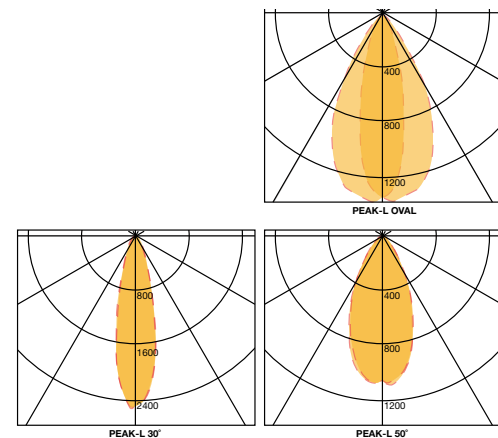

STEM TREE

360 ° luminaires Bollards system.

STEM-TREE는 2개의 360도 틸트 가능한 소형 파이프 구조의 볼라드 제품입니다. 보행자를 위한 스탭등의 역할과 수목을 자유롭게 비출 수 있는 타입으로, 기존의 등 기구가 가지고 있는 연출 제약을 극복한 제품입니다. 공원 및 조경 현장의 다양한 연출 목적에 부합하는 경량형 제품입니다.

STEM-TREE is 360 degree tilt-able compact bollards. It works as a step-light for pedestrian as well as light for trees and garden which overcome the limit of prior aiming method.

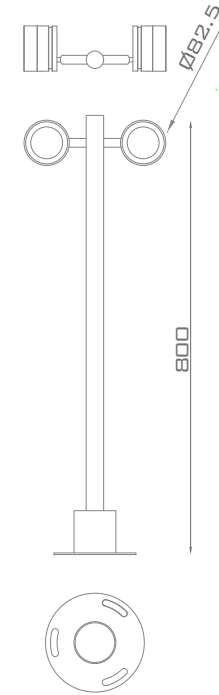

STEM TREE

개별 지향형 투광등은 다이캐스팅 알루미늄으로 제작되었습니다.
제품의 베이스는 스테인레스 스틸로 제작되었습니다.
강화유리 적용(투명 유리) 단일 COB 위 렌즈 적용(20° , 60° , Oval)

각각의 광원 부는 각도 조절이 가능합니다.
각 모듈은 손쉽게 상하좌우 조절이 가능합니다.

Each floodlight luminaire is made of aluminum.
Base is made of stainless steel.
Safety glass(clear type)
Floodlights with reflector(20° , 60° , Oval)

Each floodlight are adjustable.

Finish color : Dark grey, on demand.

BODY : Aluminium die-casting
POLE : Stainless steel
SIZE : W250 x L250 x H800
CRI : ≤90
Lamp : LED 10W / 15W
I V : Constant Current / AC Drive
C T : 3000K, 4000K

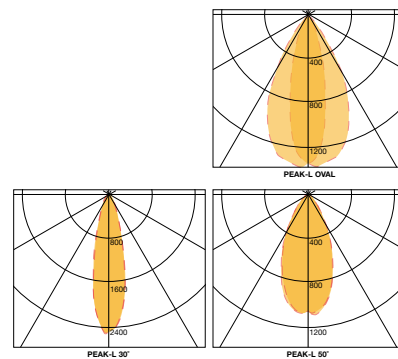

HEXAGON

LED garden and pathway luminaires.
symmetrical wide beam light distribution



HEXAGON은. 글레어 없는 빛을 만들고 보행 동선을 통일성있게 만듭니다.
정적인 조경용 조명 역할과 차분한 분위기를 만듭니다.
경제적이고 효율적인 ECO-LED 기술을 적용하여, 유지관리 측면이 좋은 조명입니다.

Luminaires that are glare-free and uniformly illuminate many situations in foot paths and terraces in private gardens and house entrances. Cost-effective and efficient LED technology makes them low-maintenance and modern luminaires for your landscape architecture project.

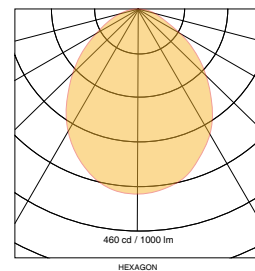

HEXAGON

제품의 바디는 캐스팅 알루미늄 및 스테인레스스틸로 제작되었습니다.
광확산 PC 적용
고효율 LED적용(3000K)
현장 여건에 따른 사이즈(H:500, 700, 900)

에코브릿지 블라드 제품은 하부고정 스테인레스스틸 플레이트와 함께 제공됩니다.
플레이트에 현장 여건에 적합한 앙카시공이 요구됩니다.

Luminaires housing made of cast aluminum, stainless steel
PC light diffuser
High effective ECO LED Module(3000K)
Three sizes for the differing dimensions of the installation site.
(H:500,700,900)

Finish color : Dark grey, on demand.

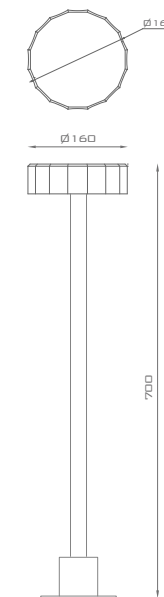

BODY : Cast aluminium
SIZE : \varnothing 160 x H700
CRI : ≤ 80
Lamp : LED 18W
I V : Constant Current
Constant Voltage
C T : 3000K

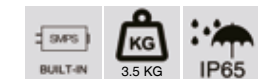

CUBO

Stainless steel outdoor lamp port for passageways.
Asymmetrical light distribution.

CUBO는 LED 볼라드로 글레어가 없는 제품입니다. 제품은 넓은 공간을 조사하여 수평적인 영역의 빛 연출에 탁월합니다. 비대칭의 광원은 광장 또는 넓은 보행로의 디자인 요소로 활용가능하며, 빛 공해 없는 공간조도확보 유리합니다.

CUBO is a LED Bollards for the glare-free illumination of ground surfaces. Luminaires for the spatial or flat beam illumination of horizontal surfaces. Luminaires with asymmetrical light distribution are particularly suitable for the illumination of squares or wider pathways on account of their spatial illumination.

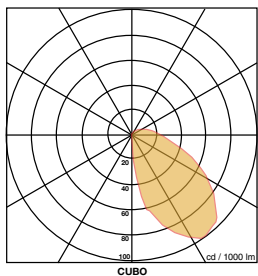

CUBO

제품의 바디는 캐스팅 알루미늄 및 스테인레스 스틸로 제작되었습니다.
광확산PC 적용
SMPS 내장/외장형

에코브릿지 볼라드 제품은 하부고정 스테인레스 스틸 플레이트와 함께 제공됩니다.
플레이트에 현장여건에 적합한 양카시공이 요구됩니다.

Luminaires housing made of cast aluminum, stainless steel
PC light diffuser
High effective ECO LED Module(3000K)
SMPS BOX Inside(Optional)

Finish color : Dark grey, on demand.

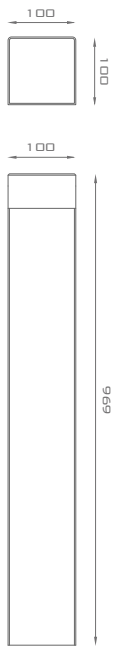

BODY : Aluminium die-casting
POLE : Stainless steel
SIZE : W100 x L100 x H696
CRI : ≤90
Lamp : LED 15W
I V : Constant Current / AC Drive
C T : 3000K, 4000K



CUTEM

Stainless steel outdoor lamp port for passageways.
Asymmetrical light distribution.

CUTEM은 LED 볼라드로 글레어가 없는 제품입니다. 제품은 넓은 공간을 조사하여 수평적인 영역의 빛 연출에 탁월합니다.
비대칭의 광원은 광장 또는 넓은 보행로의 디자인 요소로 활용가능하며, 빛 공해 없는 공간조도확보 유리합니다.
제품 상부에는 자유각도로 에이밍이 가능한 투광모듈이 있습니다. 다양한 연출 환경에 적합한 제품입니다.

CUTEM is a LED Bollards for the glare-free illumination of ground surfaces. Luminaires for the spatial or flat beam illumination of horizontal surfaces.
Luminaires with asymmetrical light distribution are particularly suitable for the illumination of squares or wider pathways on account of their spatial illumination.
There is a floodlight module at the top of the product that allows aiming at any angle. This product is suitable for a variety of light environments.

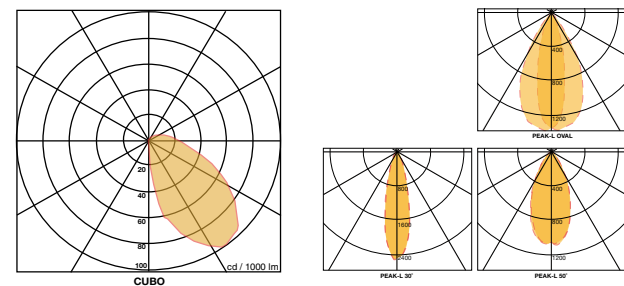

CUTEM

제품의 바디는 캐스팅 알루미늄 및 스테인레스 스틸로 제작되었습니다.
광확산PC 적용
SMPS 내장/외장형

에코브릿지 볼라드 제품은 하부고정 스테인레스 스틸 플레이트와 함께 제공됩니다.
플레이트에 현장여건에 적합한 앙카시공이 요구됩니다.

Luminaires housing made of cast aluminum, stainless steel
PC light diffuser
High effective ECO LED Module(3000K)
SMPS BOX Inside(Optional)

Finish color : Dark grey, on demand.

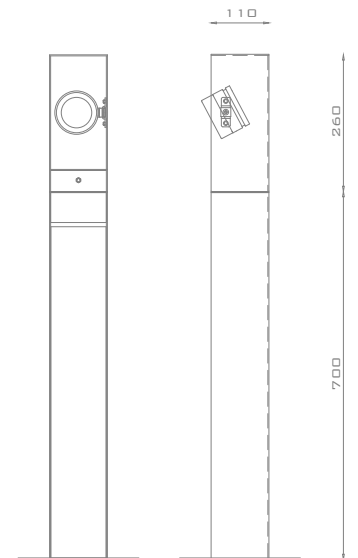

BODY : Aluminium die-casting
POLE : Stainless steel
SIZE : W110 x L110 x H960
CRI : ≤ 90
Lamp : LED 15W Bollards, 15W Floodlights
I V : Constant Current / AC Drive
C T : 3000K, 4000K



GRID

Decorative outdoor bollards with shadow effects

GRID는 아름다운 광원효과를 지닌 조명 공간에 재미를 부여합니다. 제품은 글레어가 없으며 보행로 또는 공원, 테라스 공간에서 균일한 빛을 조사합니다. 경제적이고 효율적인 ECO-LED 기술을 적용하여, 유지관리 측면이 좋은 조명입니다.

Grid is a luminaires which creates a beautiful light and shadow effect illuminating certain areas of your outdoor spaces. It is also glare-free and uniformly illuminate many situations in foot paths and terraces in private gardens and house entrances. Cost-effective and efficient LED technology makes them low-maintenance and modern luminaires for your landscape architecture project.

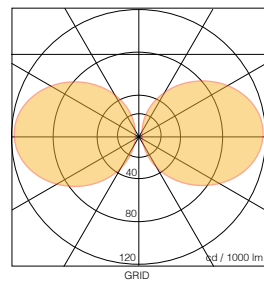

GRID

제품의 바디는 알루미늄 및 스테인레스 스틸로 제작되었습니다.
광확산PC 적용
SMPS 내장형 / 외장형

에코브릿지 볼라드 제품은 하부고정 스테인레스 스틸 플레이트와 함께 제공됩니다.
플레이트에 현장여건에 적합한 앙카시공이 요구됩니다.

Luminaires housing made of aluminum, stainless steel
PC light diffuser
High effective ECO LED Module(3000K)
SMPS BOX Inside(Optional)

Finish color : Dark grey, on demand.

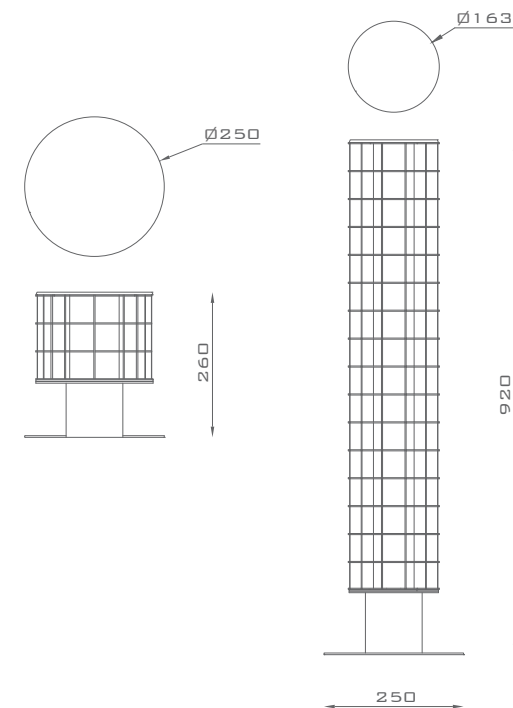

BODY : Aluminium die-casting
POLE : Stainless steel
SIZE : $\varnothing 163$, 250 x H260, 920
CRI : ≤ 90
Lamp : LED 10W, 20W
I V : Constant Current / AC Drive
C T : 3000K, 4000K



GRID LONG TYPE



GRID SHORT TYPE

DAON CUSTOM

Stainless steel Decorative outdoor lamp
Custom-made

DAON-CUSTOM은 주문제작 형식의 볼라드 제품입니다. 현장 특성에 부합하는 제품의 디자인과 패턴으로 다양한 연출 의도에 부합하는 제품입니다. 다수 현장에 납품한 다양한 형태의 제품으로 행사 및 공간에 다양한 캐릭터를 부여합니다.

DAON-CUSTOM is a Custom made LED Bollards. The design and pattern of the product can be customized depends on site. It's a variety of products delivered to many sites, giving various characters to events and spaces.



DAON-CUSTOM

제품의 바디는 스테인레스 스틸로 제작되었습니다.
광확산PC 또는 아크릴 적용
SMPS 내장/외장형

에코브릿지 볼라드 제품은 하부고정 스테인레스 스틸 플레이트와 함께 제공됩니다. 플레이트에 현장여건에 적합한 양카사공이 요구됩니다.

Luminaires housing made of aluminum, stainless steel
PC or Acrylic light diffuser
High effective ECO LED Module(3000K,4000K)
SMPS BOX Inside(Optional)

Finish color : Custom-made, on demand.



BODY : Aluminium
POLE : Stainless steel
SIZE : Custom made
CRI : ≤90
Lamp : LED 10W, 15W, 20W
I V : Constant Current / AC Drive
C T : 3000K, 4000K, RGB, TW



DAON ROUND

LED garden and pathway luminaires.
symmetrical wide beam light distribution

DAON ROUND는 전통 모티브에 간결한 디자인을 더한 볼라드 제품입니다.

손잡이 형태의 디자인을 가미하여 필요시에는 가설조명으로 사용될 수 있으며, 상시 설치시에도 간결하며 독특한 형태로 다양한 공간에서 사용될 수 있는 볼라드 제품입니다.

DAON ROUND is a bollard product that adds a korean traditional motif and a modern design.
Its design can be used as temporary lighting if necessary ,and naturally even when installed permanently.
It is a bollard product that can be used in various spaces in a simple and unique form.

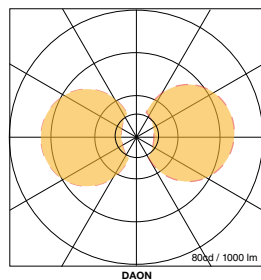

DAON ROUND

제품의 바디는 스테인레스 스틸로 제작되었습니다.
미스트 처리된 폴리카보네이트 적용

에코브릿지 볼라드 제품은 하부고정 스테인레스 스틸 플레이트와 함께 제공됩니다.
플레이트에 현장여건에 적합한 양카시공이 요구됩니다.

Luminaires housing made of stainless steel
PC light diffuser(Misted)
ECO_E26 Module(3000K,4000K)

Finish color : Dark grey, on demand.

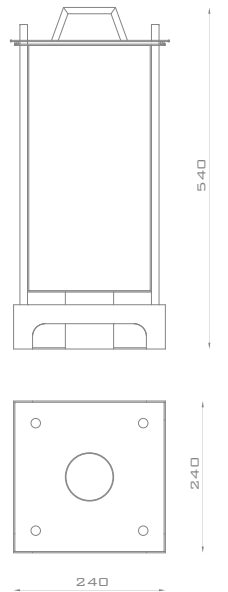

BODY : Stainless steel
SIZE : W240 x L240 x H540
CRI : ≤90
Lamp : LED 10W, 15W
I V : E26, AC Drive
C T : 3000K, 4000K



DAON SHADE

LED garden and pathway luminaires.
symmetrical wide beam light distribution

DAON SHADE는 전통등 모티브에 모던 디자인을 가미한 볼라드 제품입니다.

필요시에는 가설조명으로 사용될 수 있으며, 상시 설치시에도 간결하며 독특한 형태로 다양한 공간에서 사용될 수 있는 장식적인 볼라드 제품입니다.

DAON SHADE is a bollard product that combines oriental traditional motif and a modern design. Its design can be used as temporary lighting if necessary and permanently as well. It is a bollard product can be used in various venues with its simple and unique form.

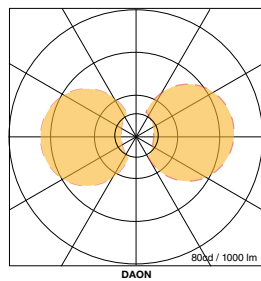

DAON SHADE

제품의 바디는 스테인레스 스틸로 제작되었습니다.

미스트 처리된 성형 유리 적용

에코브릿지 볼라드 제품은 하부고정 스테인레스 스틸 플레이트와 함께 제공됩니다.

플레이트에 현장여건에 적합한 앙카시공이 요구됩니다.

Luminaires housing made of stainless steel
Glass diffuser(Frosted)
ECO_E26 Module(3000K,4000K)

Finish color : Black, on demand.

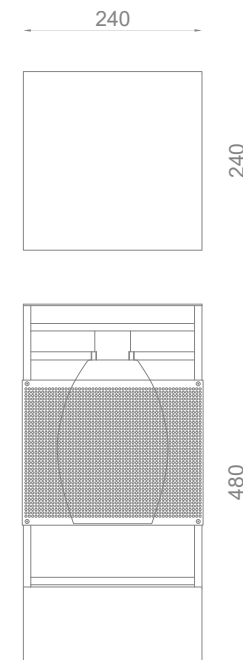

BODY : Stainless steel
SIZE : W240 x L240 x H480
CRI : ≤90
Lamp : LED 10W
I V : E26, AC Module
C T : 3000K



WIDER

LED garden and pathway luminaires.
symmetrical wide beam light distribution

WIDER는 심플하고 모던한 형태의 조명기구이나 광학렌즈를 사용하여 넓은 배광으로 안전한 보행환경을 확보하는데 매우우수합니다. 넓은 배광으로 상대적으로 적은 수량으로 높은 평균 조도의 밝은 보행환경을 확보할 수 있는 경제성이 뛰어난 제품입니다.

WIDER is a simple and modern lighting fixture that excels in ensuring a safe pedestrian environment with its wide beam distribution achieved through advanced optical lenses. Its broad light coverage allows for the creation of bright pedestrian areas with relatively fewer units, ensuring high average illuminance. This makes it an economical and highly efficient choice.

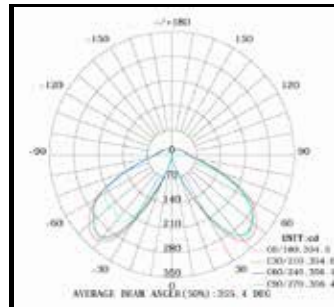

WIDER

제품의 바디는 스테인레스 스틸로 제작되었습니다.
제품에는 고성능의 렌즈 타입 모듈이 적용되었습니다.

에코브릿지 볼라드 제품은 하부고정 스테인레스 스틸 플레이트와 함께 제공됩니다.
플레이트에 현장여건에 적합한 앙카시공이 요구됩니다.

Luminaires housing made of stainless steel
LED High Performance Module(Lens Type)

Finish color : Dark grey, on demand.

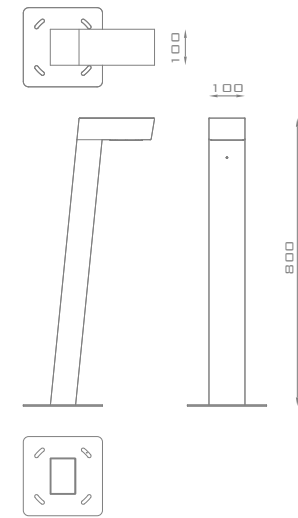

BODY : Stainless steel
SIZE : W360 x L240 x H800
CRI : ≤80, 90
Lamp : LED 15W
I V : Constant Current
C T : 3000K, 4000K

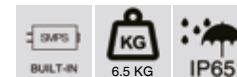

STAMP

LED garden and pathway luminaires.
symmetrical Pattern distribution

STAMP는 공공 디자인 설계에서 재미있는 아이디어를 부여할 수 있는 제품입니다.
제품의 상부에 위치한 광원에서 제품 바디에 있는 패턴을 바닥면에 투사시켜 바닥면에 패턴을 만드는 제품입니다.
상시 설치시에도 패턴 형태가 부각되어 디자인 요소로 다양한 공간에서 활용이 가능합니다.

STAMP is a product that brings fun and creative ideas to public design projects.
The light source located at the top of the fixture projects patterns from the product body onto the ground, creating unique designs on the surface. Even when installed permanently, the visible patterns enhance its design elements, making it versatile for use in various spaces.

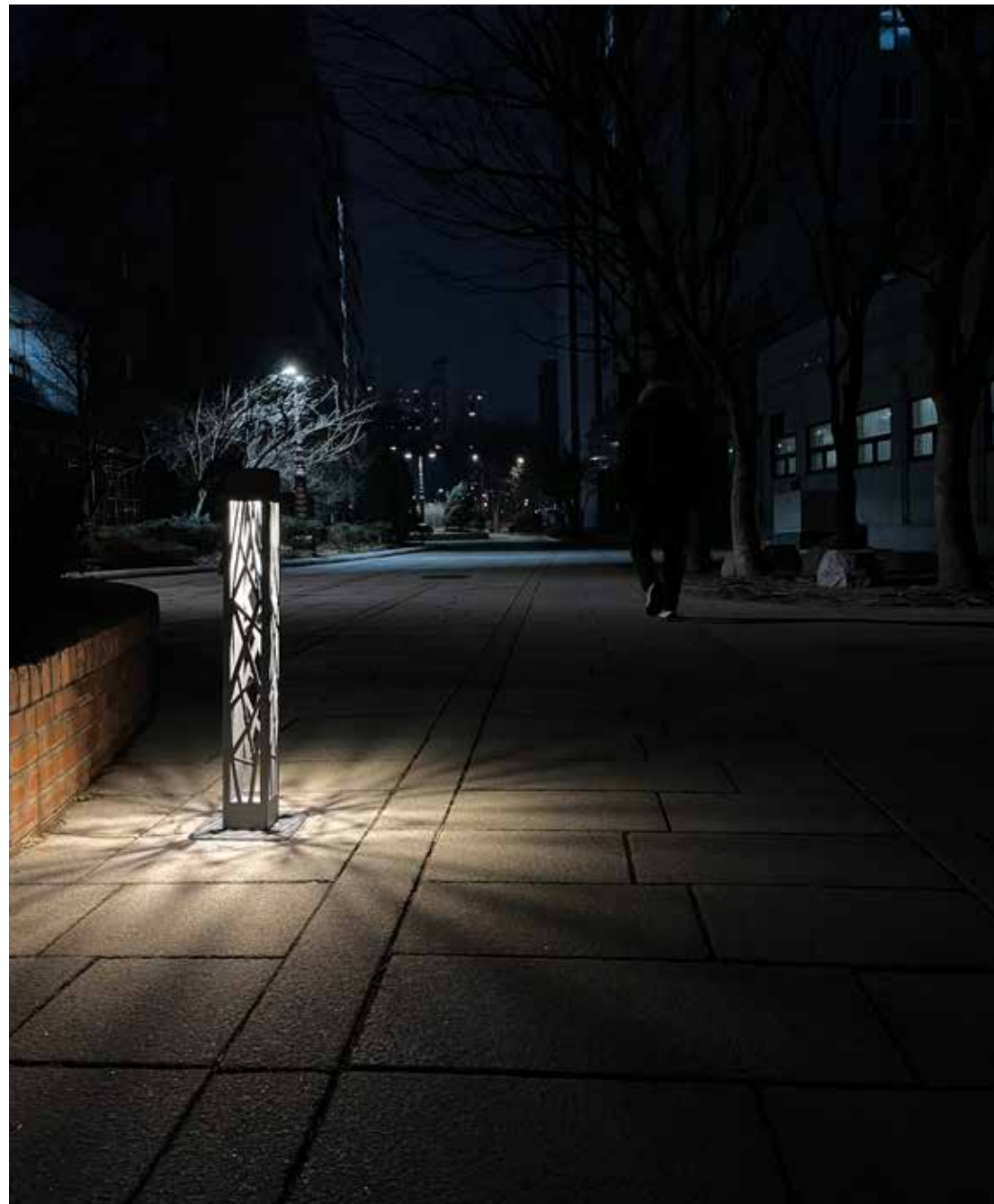

STAMP

제품의 바디는 스테인레스 스틸로 제작되었습니다.
제품에는 고성능의 렌즈 타입 모듈이 적용되었습니다.

에코브릿지 볼라드 제품은 하부고정 스테인레스 스틸 플레이트와 함께 제공됩니다.
플레이트에 현장여건에 적합한 양카시공이 요구됩니다.

Luminaires housing made of stainless steel
LED High Performance Module(Lens Type)

Finish color : Dark grey, on demand.

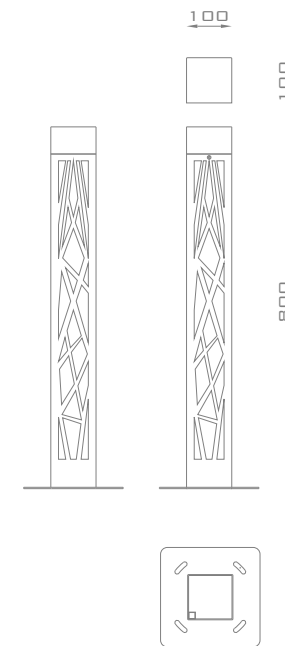

BODY : Stainless steel
SIZE : W240 x L240 x H800
CRI : ≤80, 90
Lamp : LED 15W
I V : Costant Current
C T : 3000K, 4000K



ECO-B001

Energy-saving and efficient LED bollards for the illumination of ground surfaces.

ECO B001은 에너지 효율성과 높은 경제성을 지닌 LED 볼라드 제품입니다. 주변 환경과의 조화를 중점적으로 생각하여 통로 구간 및 건축물 그리고 자연과 조화된 위화감 없는 디자인을 의도하였습니다. 또한 제품에서 발생하는 글레어를 효과적으로 통제하여 보행자 친화적인 옥외 조명환경을 구현합니다.

ECO B001 is an energy-efficient and highly economical LED bollard.

Designed with a focus on harmony with its surroundings, it seamlessly integrates with pathways, architectural structures, and natural landscapes without disrupting the aesthetic balance.

Additionally, it effectively controls glare, creating a pedestrian-friendly outdoor lighting environment.

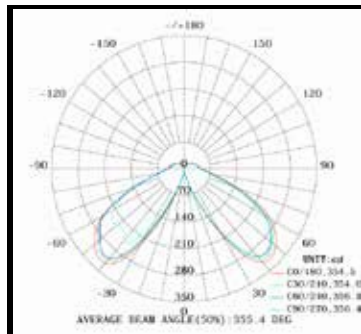

ECO-B001

제품의 바디는 캐스팅 알루미늄 및 스테인레스 스틸로 제작되었습니다.
강화유리 적용(투명 유리) 고효율 LED PKG 적용(3000K, 4000K)

해당 볼라드 제품은 베이스가 내부로 숨겨진 디자인의 제품으로
시공용 세트양카가 동봉되어 있습니다.
스펙도면 및 상세도를 참고한 적합한 양카 시공이 요구됩니다.

Luminares housing made of Diecast aluminum, Stainless steel
Safety glass(Frosted type)
High effective ECO LED Package(3000K,4000K)
Hidden Base type(Set Anchor Bolt included)

Finish color : Dark grey Only

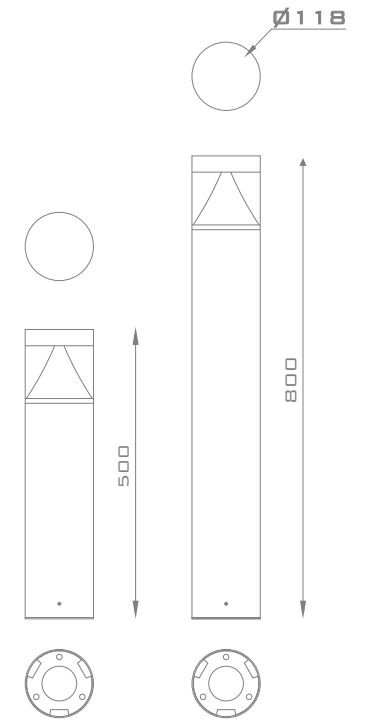

BODY : Aluminium
SIZE : $\varnothing 118 \times H 500, 800$
CRI : ≤ 80
Lamp : LED 12W
I V : Constant Voltage
C T : 3000K, 4000K



ECO-B002

Energy-saving and efficient LED bollards for the illumination of ground surfaces.

ECO B002는 에너지 효율성과 높은 경제성을 지닌 LED 볼라드 제품입니다. 주변 시설과의 조화를 우선으로 생각하였으며 주거지의 보행공간 및 건축물 그리고 자연과 조화된 위화감 없는 디자인을 보여줍니다. 또한 제품에서 발생하는 글레어를 효과적으로 통제하여 보행자 친화적인 옥외 조명환경을 구현합니다.

ECO B002 is an energy-efficient and highly economical LED bollard.

Designed with a focus on harmony with its surroundings, it seamlessly integrates with pathways, architectural structures, and natural landscapes without disrupting the aesthetic balance.

Additionally, it effectively controls glare, creating a pedestrian-friendly outdoor lighting environment.

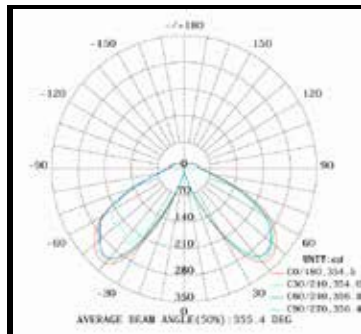

ECO-B002

제품의 바디는 캐스팅 알루미늄 및 스테인레스 스틸로 제작되었습니다.
강화유리 적용(투명 유리) 고효율 LED PKG 적용(3000K, 4000K)

해당 볼라드 제품은 베이스가 내부로 숨겨진 디자인의 제품으로
시공용 세트양카가 동봉되어 있습니다.
스펙도면 및 상세도를 참고한 적합한 양카 시공이 요구됩니다.

Luminares housing made of Diecast aluminum, Stainless steel
Safety glass(Frosted type)
High effective ECO LED Package(3000K, 4000K)
Hidden Base type(Set Anchor Bolt included)

Finish color : Dark grey Only

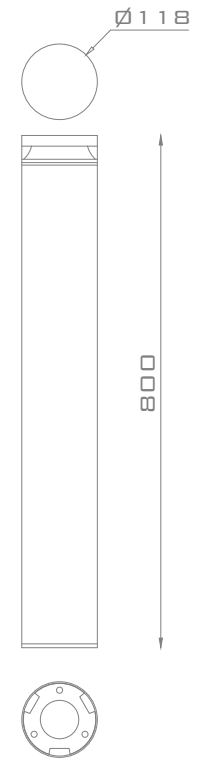

BODY : Aluminium
SIZE : $\Phi 118 \times H800$
CRI : ≤ 80
Lamp : LED 12W
I V : Constant Voltage
C T : 3000K, 4000K



ECO-B003

Energy-saving and efficient LED bollards for the illumination of ground surfaces.

ECO-B003은 면발광 LED 제품으로 미니멀한 디자인과 도시 환경에 필수적인 빛을 제공합니다.

이 제품은 양면 또는 단면 발광이 가능하며 광원이 노출되는 구조이지만 폴리카보네이트 디퓨저를 사용해 눈부심을 최소화했습니다. 또한 세련되고 절제된 디자인 요소를 갖추고 있어 다양한 현장에서 활용할 수 있습니다.

ECO-B003 is a surface-emitting LED product that provides essential lighting for urban environments with its minimalist design. It offers both dual-sided and single-sided illumination, featuring an exposed light source that is softened by a polycarbonate diffuser to minimize glare. With its sleek design elements, it can be adapted for a variety of applications.

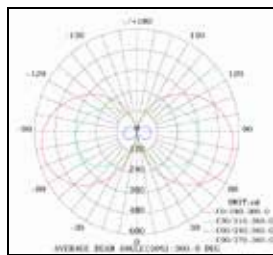

ECO-B003

제품의 바디는 캐스팅 알루미늄 및 스테인레스 스틸로 제작되었습니다.
강화유리 적용(투명 유리) 고효율 LED PKG 적용(3000K, 4000K)

해당 볼라드 제품은 베이스가 내부로 숨겨진 디자인의 제품으로
시공용 세트앙카가 동봉되어 있습니다.
스펙도면 및 상세도를 참고한 적합한 앙카 시공이 요구됩니다.

Luminaires housing made of Diecast aluminum, Stainless steel
Safety glass(Frosted type)
High effective ECO LED Package(3000K,4000K)
Hidden Base type(Set Anchor Bolt included)

Finish color : Dark grey Only

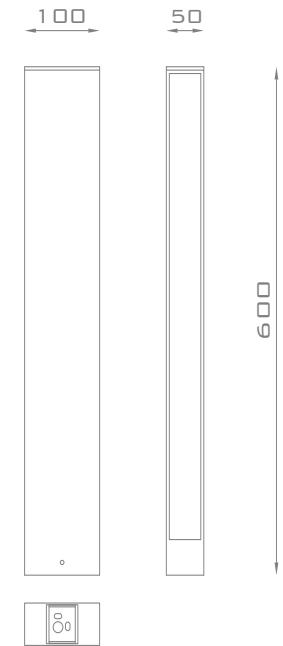

BODY : Aluminium
SIZE : W100 x L50 x H600
CRI : ≤80, 90
Lamp : LED 12.5W X 2EA (25W)
I V : Constant Current
C T : 3000K, 4000K



ECO-B004

Energy-saving and efficient LED bollards for the illumination of ground surfaces.

ECO-B004는 광원이 드러나지 않는 LED 볼라드제품입니다. 유려한 디자인으로 도시 환경에 잘 어울리며, 렌즈 기술을 활용하여 전방으로 매우 효과적으로 치고나가는 배광을 가지고 있습니다. 상대적으로 적은 수량으로 높은 평균 조도의 밝은 보행환경을 확보할 수 있는 경제성이 뛰어난 제품입니다.

The ECO-B004 is an LED bollard product with a concealed light source, designed to provide a safe walking environment through wide and highly efficient light distribution. Its expansive light coverage ensures high average brightness with relatively fewer units, making it a cost-effective solution.

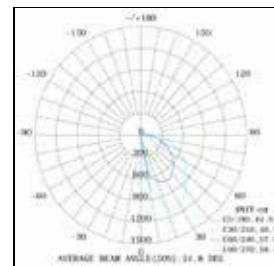
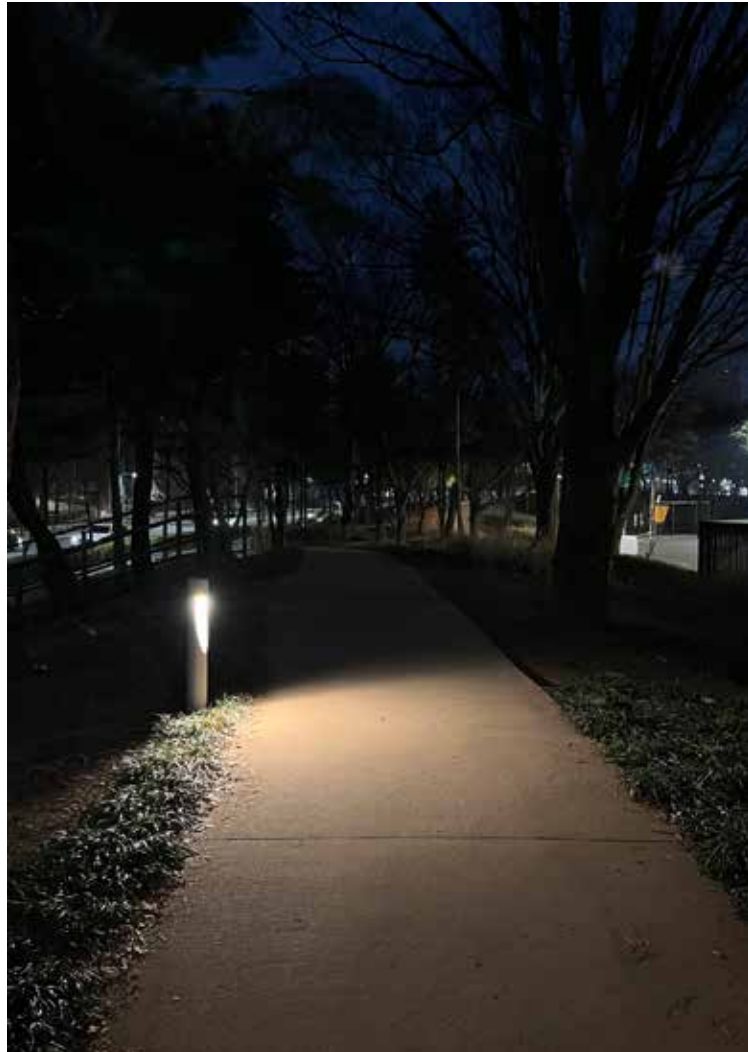

ECO-B004

제품의 바디는 캐스팅 알루미늄 및 스테인레스 스틸로 제작되었습니다.
강화유리 적용(투명 유리) 고효율 LED PKG 적용(3000K, 4000K)

해당 볼라드 제품은 베이스가 내부로 숨겨진 디자인의 제품으로
시공용 세트양카가 동봉되어 있습니다.
스펙도면 및 상세도를 참고한 적합한 양카 시공이 요구됩니다.

Luminaires housing made of Diecast aluminum, Stainless steel
Safety glass(Frosted type)
High effective ECO LED PKG.(3000K,4000K)
Hidden Base type(Set Anchor Bolt included)

Finish color : Dark grey Only

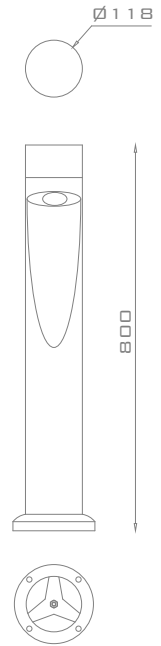

BODY : Aluminium
SIZE : 118 x H800
CRI : ≤80
Lamp : LED 15W
I V : Constant Current
C T : 3000K, 4000K





Linear luminaires
Line bars, flexible bar

FLEX

Flexible light strip resistant against water and dust. Ideal for architectural or path illumination.



FLEX 제품은 IP67 등급의 플렉시블바로서, 강력한 방수능력으로 다양한 건축 조명, 통로 조명으로 적합합니다. airGap 기술을 적용하여, 높은 제품 보호력을 가지고, 안정적인 색온도 유지가 가능합니다. 제품의 색온도와 질이 중요한 현장에 완벽한 제품입니다

Flex is IP67 rated flexible light strip. It is therefore ideal for usage in areas need water-proofness i.e architectural or path illumination. With the innovative airGAP technology is able to provide high protection but still achieve a stable color temperature and no color shift. FLEX is a perfect fit where the light-color and quality is important.

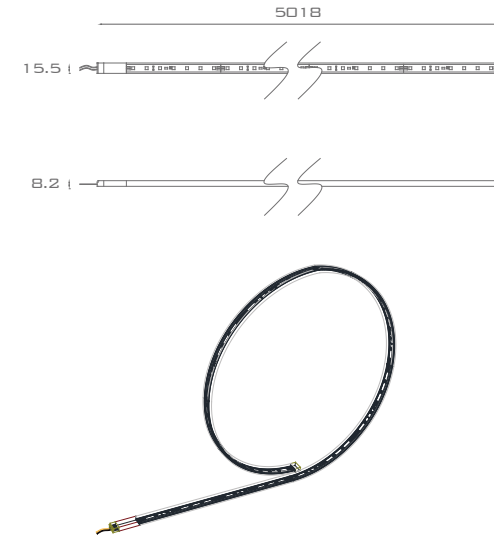
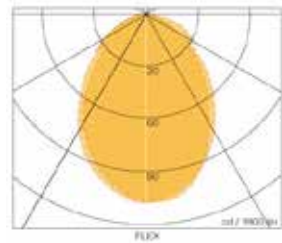

FLEX IP67 EXC2

IP67 등급: 방수 방진 색온도 2700, 3000, 4000K(SDCM 3) 최대 119lm/W 제품 모듈 효율 다양한 표면에 적용 가능한 접착테이프 후면 부착. 추가적인 히트싱크가 필요 없는 셀프 쿨링 시스템 적용 최대 50,000 시간 장주기 사용 가능

IP67: protected against water & dust, Color temperature 2,700, 3,000 and 4,000K with SDCM 3 Efficacy of the module up to 119 lm/W, Self-adhesive 3M tape at the backside for simple mounting on different surfaces. Self-cooling(no additional heat sink required) Long life-time up to 50,000 hours.

BODY : Silicone
 CLIP : Stainless steel
 SIZE : W5,018 x L15.5 x H8.2
 CRI : ≤90
 Lamp : LED 5W / 11W / 16W
 I V : Constant Voltage 24V
 C T : 2700K, 3000K, 4000K



FREEBEND

Free bending flexible silicone wall washer light



FREEBEND는 다양한 옥외환경의 커브와 곡면에 적용가능한 제품입니다.
벽체워싱, 기둥투사, 수목투사, 조형물투사 등 다양한 목적성에 부합하는 제품입니다. 제품은 실리콘 몰딩 프로세스를 거쳐 소금,산,알카리 부식에 강하고, 자외선에도 강한 제품입니다.
또한 다양한 각도의 렌즈옵션을 가지고 있습니다.

FREEBEND can perfectly fit the outdoor curved surface of various arcs to achieve the effect of wall washing.
it has intergrated extrusion molding process, a waterproof grade up to IP65 and patented optical structure design with a variety of angles optional.

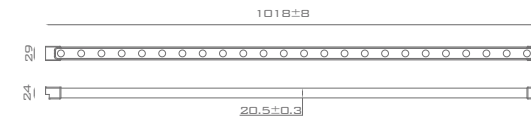
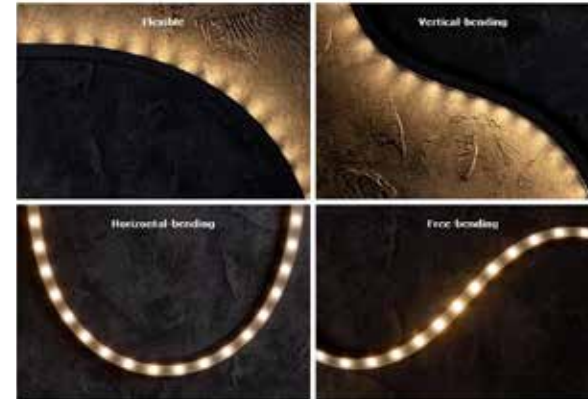

FREEBEND

제품의 바디는 실리콘으로 제작되었습니다.
밴딩 내경은 최소 400mm입니다.

*제품에 대한 배광 약세사리 설치방법 결선 등
자세한 정보는 별도 상담 요청바랍니다.

Luminaire's body is made of silicone.
minimum bending diameter is 400mm

For more details please request 'Freebend Catalogue'

Lens option : 15°, 30°, 50°, Wall-washers
Finsh color : Grey

BODY : Silicone
SIZE : W29 x H24 x H1018
CRI : ≤80
Lamp : LED 24W/M(1580lm/M-3000K)
I V : Constant voltage
C T : MONO, RGBW



S-MONO / S-TW
LED Linear Bar



S-MONO / TW는 다양한 직선적인 옥외 환경에 적용 가능한 제품입니다. 벽체위싱, 기둥투사, 수목투사, 조형물 투사 등 다양한 목적성에 부합하는 제품입니다. 제품은 방열 프로파일 방수 몰딩 프로세스를 거쳐 강한 방수 성능을 지녔으며 강력한 성능을 발휘합니다.

S-MONO / TW can perfectly fit the Linear surface of various areas to achieve the effect of wall washing. it has intergrated Profile molding process, a waterproof grade up to IP 67.

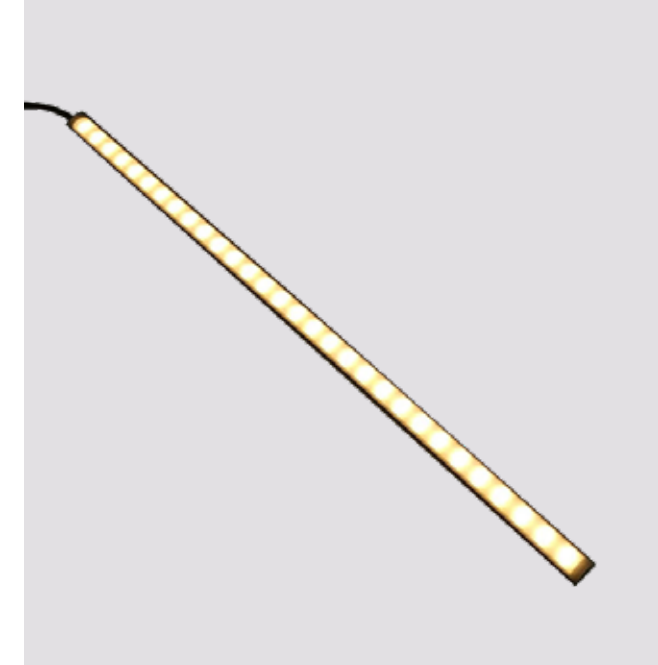
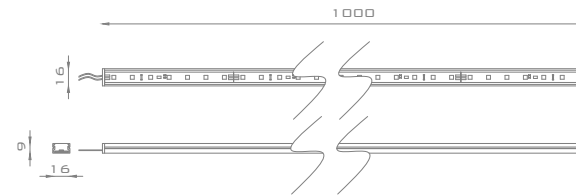
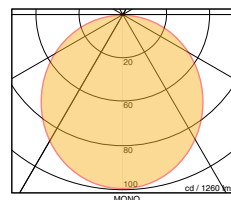

S-MONO / S-TW

제품의 바디는 알루미늄으로 제작되었습니다.
제품은 방수를 위한 패키징 몰딩처리 되어있습니다.

*제품에 대한 배광 약세사리 설치방법 결선 등
자세한 정보는 별도 상담 요청바랍니다.

Luminaire's body is made of Aluminium
Waterproof molding

Finsh color : Grey
Basic Acceseries(Clip) Included

BODY : Extruded Aluminium
SIZE : W16 x H9 x L1,000
CRI : ≤90
Lamp : Mono. 14W/M(90lm/W)
TW. 30W/M(95lm/W)
I V : Constant Voltage
C T : MONO(3,000K to 4,000K)
TW(2,700K to 6,500K)



ECO-SIDE

Free bending flexible silicone side-view wall washing light

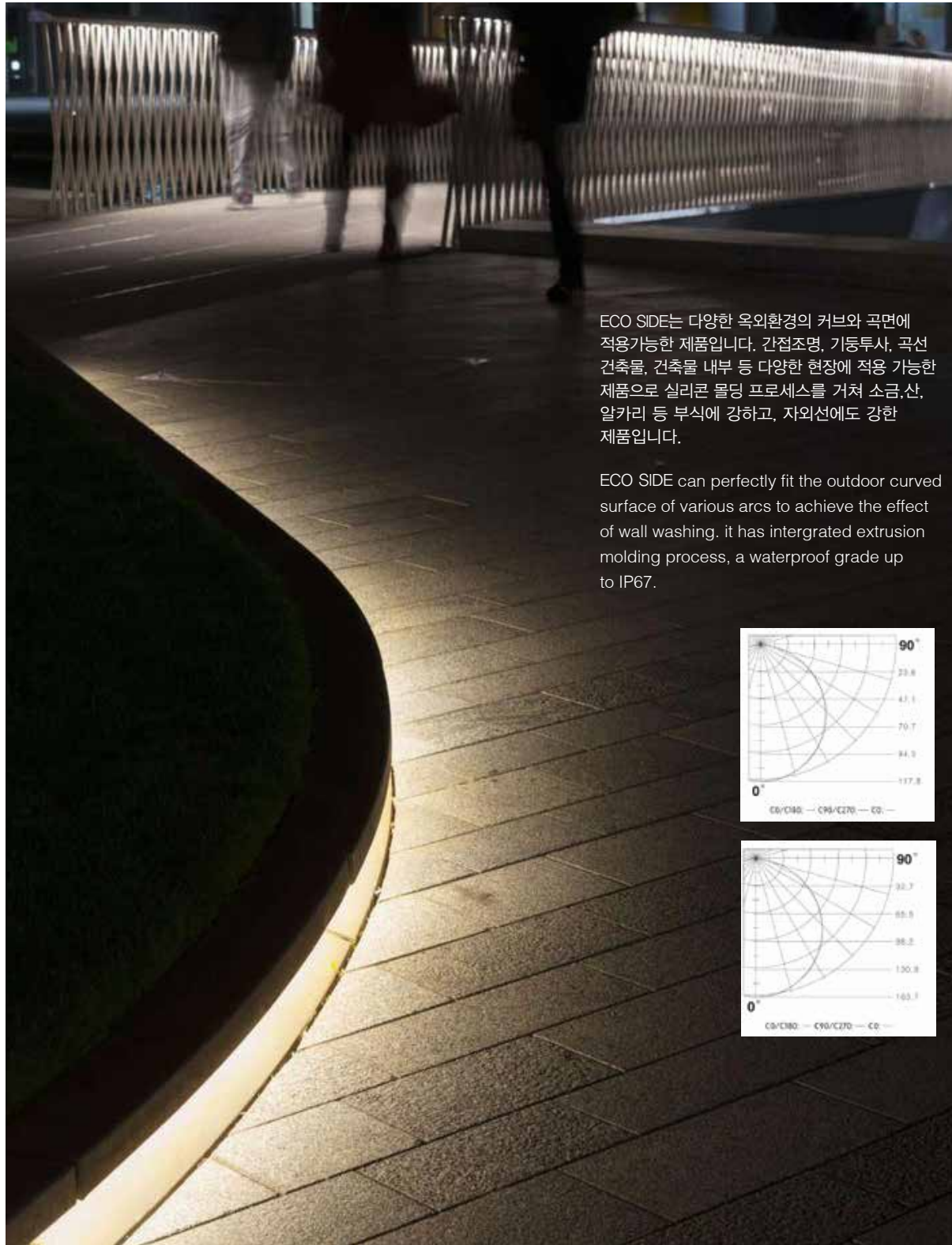

ECO SIDE는 다양한 옥외환경의 커브와 곡면에 적용가능한 제품입니다. 간접조명, 기둥투사, 곡선 건축물, 건축물 내부 등 다양한 현장에 적용 가능한 제품으로 실리콘 몰딩 프로세스를 거쳐 소금, 산, 알칼리 등 부식에 강하고, 자외선에도 강한 제품입니다.

ECO SIDE can perfectly fit the outdoor curved surface of various arcs to achieve the effect of wall washing. it has intergrated extrusion molding process, a waterproof grade up to IP67.

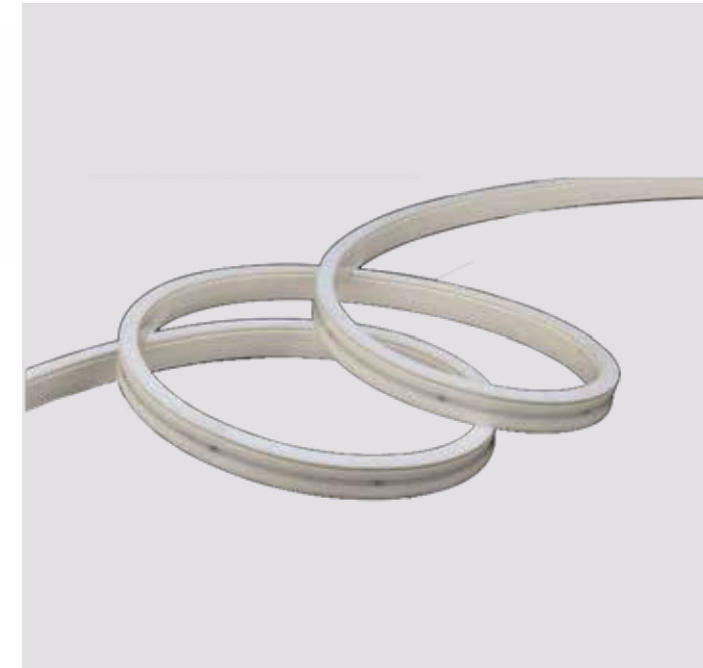
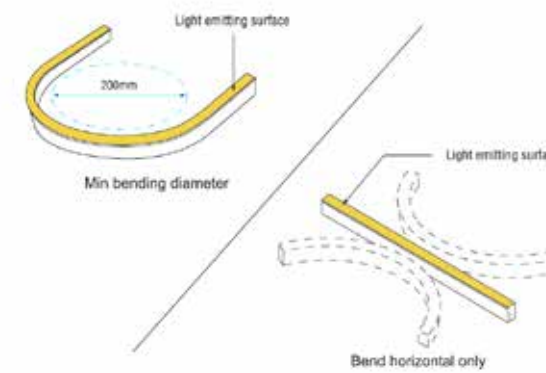
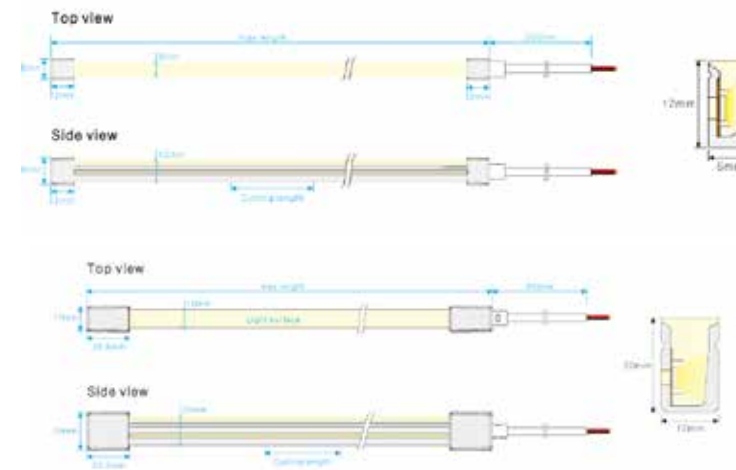
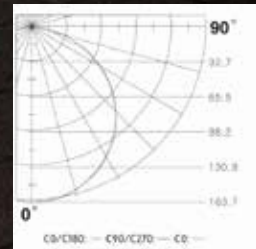
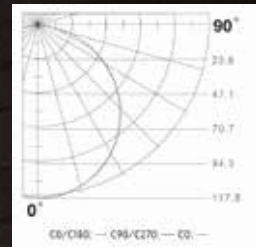

ECO-SIDE

Dow Chemical SILASTIC™ 적용(고강도, 고투명도)
 염수, UV, 방염, 약산성, 알칼리 내성
 IP 68 성능(염소 내성)
 밴딩 내경 최소 200mm

*제품에 대한 배광 약세사리 설치방법 결선 등
 자세한 정보는 별도 상담 요청바랍니다.

Dow Chemical SILASTIC™
 IP68 protection level, Chlorination resistant
 salt solution resistance,
 weak acid and alkali corrosion,
 corrosive gases, fire and UV.
 minimum bending diameter is 200mm

BODY : Silicone
 SIZE : W6 x H12 x Cutting length
 W12 x H20 x Cutting length
 CRI : ≤90
 Lamp : LED 10W/M(307lm/m, 3,000K)
 LED 15W/M(432lm/m, 3,000K)
 I V : Constant Voltage
 C T : MONO, TW, RGBW





Floodlights
High efficiency ECO Flood-lights

CANON

Surface-mounted floodlight

캐논은 움직이며 설치할 수 있는 지면 설치용 투광등입니다. 포설 전원선, 케이블 설치, 팩 타입 설치 등 다양한 적용이 가능 합니다. 상향으로 대칭 형태의 광원을 발생시켜, 수목 투사에 특화된 조명입니다. 다년간의 현장 설치를 통해 매우 안정화된 성능을 보증 받았으며, 기구 내 환기 시스템으로 결로 등 극한 상황에서 발군의 성능을 보여줍니다.

CANON is a portable surface-mounted floodlight with connecting cable and power plug. Symmetrical light distribution direct upwards for illumination of trees, bushes and other objects. It has high reliability in harsh conditions and self-ventilation system.

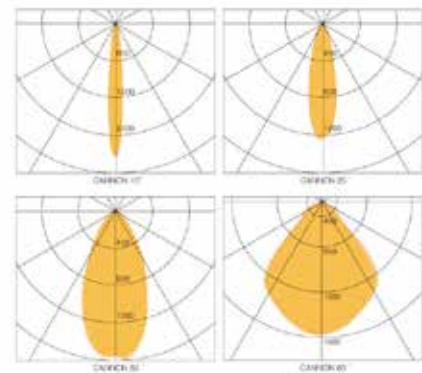

CANON

제품의 하우징은 다이캐스팅 알루미늄으로 제작되었습니다. 제품 내부의 링구 및 부속자재는 스테인레스 스틸로 제작되었습니다. 강화유리 적용(투명 유리) 반사판 적용한 투광 타입(대칭 타입 20°, 45°)

광원부의 상하 조절이 가능합니다. 상 하 45° 조절이 가능합니다.

Housing made of die-casting aluminum.
Frame ring and accessories are made of stainless steel.
Safety glass(clear type, sanding type optional)
Floodlights with reflector(Symmetrical 20°, 45°)

Floodlight can be tilted, light module can rotate up and down 0 to 45 degree.

Finsh color : Dark grey, on demand.

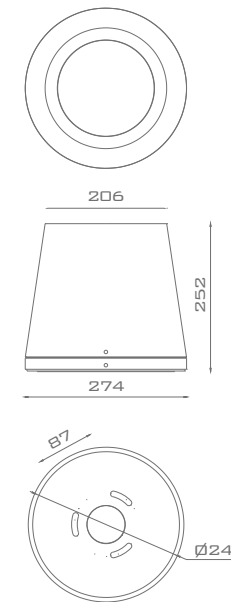

BODY : Aluminium die-casting
SIZE : $\Phi 274 \times H252$
CRI : ≤ 90
Lamp : LED 20W / 40W
I V : Constant Current
Constant Voltage
C T : 3000K / 4000K /
Tunable White / RGBW



CANON-S

Surface-mounted floodlight



CANON-S는 컷오프 형태로 보행자에게 눈부심을 최소화 할 수 있게 틸팅 디자인된 On-ground 투광등입니다. 포설 전원선, 케이블 설치, 팩 타입 설치 등 다양한 적용이 가능합니다. 상향으로 대칭 형태의 광원을 발생시켜, 수목 투사에 특화된 조명입니다. 다년간의 현장 설치를 통해 안정화된 성능을 보증 받았으며, 컴팩트한 형태에 하자율은 지중등에 비해 매우 적은 제품입니다.

CANON-S is surface-mounted floodlights with connecting cable and power plug.
Symmetrical light distribution direct upwards for illumination of trees, bushes and other objects.
It has high reliability in harsh conditions which guarantee stable performance compare to in-ground lights.

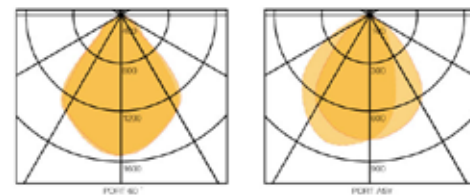

CANON-S

Surface-mounted flood light

제품의 하우징은 다이캐스팅 알루미늄으로 제작되었습니다.
제품 내부의 링구 및 부속자재는 스테인레스 스틸로 제작되었습니다.
강화유리 적용(투명 유리) 반사판 적용한 투광 타입
(비대칭 타입, 60°)
현장여건에 따라 글레어 방지를 위한 특수 루버 적용이 가능합니다.

Housing made of die-casting aluminum.
Frame ring and accessories are made of stainless steel. Safety glass(clear type)
Floodlights with reflector(Asy, 60°)

Finish color : Dark grey, Dark brown, on demand.

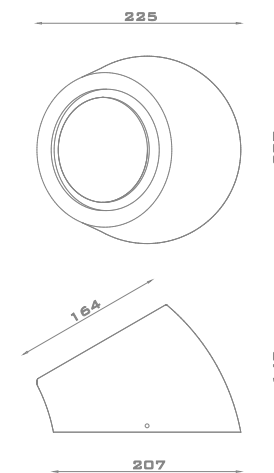

BODY : Aluminium die-casting
SIZE : W225 x D207 x H140
CRI : ≤90
Lamp : LED 8W / 15W / 20W
I V : AC Drive
C T : 3000K, 4000K



PORT

Surface-mounted floodlight



포트는 컷오프 형태로 보행자에게 눈부심을 최소화 할 수 있게 디자인된 On-ground 투광등입니다. 포설 전원선, 케이블 설치, 팩 타입 설치 등 다양한 적용이 가능합니다. 상향으로 대칭 형태의 광원을 발생시켜, 수목 투사에 특화된 조명입니다. 다년간의 현장 설치를 통해 매우 안정화된 성능을 보증 받았으며, 컴팩트한 형태에 하자율은 지중등에 비해 매우 적은 제품입니다.

PORT is portable surface-mounted floodlights with connecting cable and power plug.
Symmetrical light distribution direct upwards for illumination of trees, bushes and other objects.
It has high reliability in harsh conditions which guarantee stable performance compare to in-ground lights.

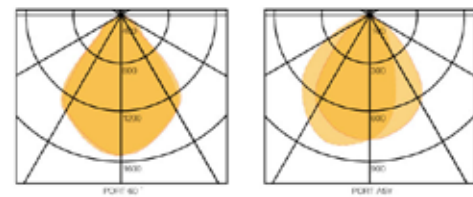

PORT

Surface-mounted flood light

제품의 하우징은 다이캐스팅 알루미늄으로 제작되었습니다.
제품 내부의 링구 및 부속자재는 스테인레스 스틸로 제작되었습니다.
강화유리 적용(투명 유리) 반사판 적용한 투광 타입
(비대칭 타입, 60°)

Housing made of die-casting aluminum.
Frame ring and accessories are made of stainless steel. Safety glass(clear type)
Floodlights with reflector(Asy, 60°)

Finish color : Dark grey, Dark brown, on demand.

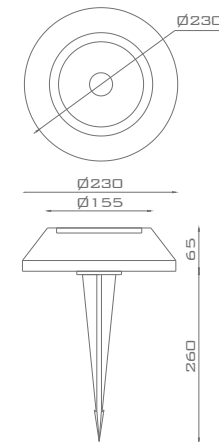
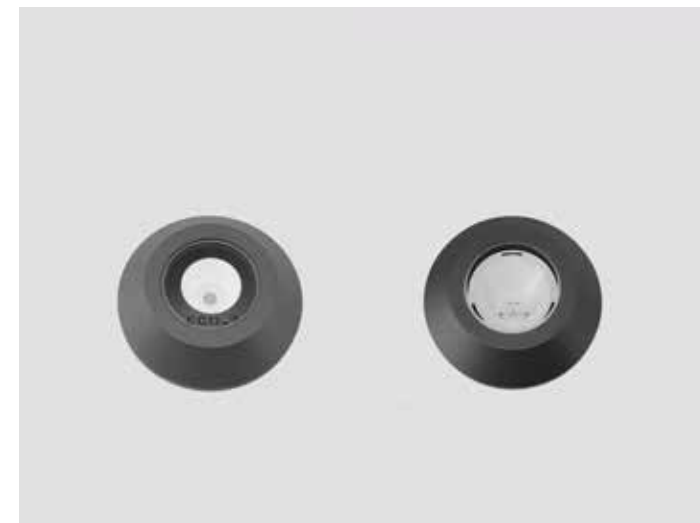

BODY : Aluminium die-casting
SIZE : $\Phi 230 \times H325$
CRI : ≤ 90
Lamp : LED 8W / 15W / 20W
I V : AC Drive
C T : 3000K, 4000K



FOREST

Surface-mounted floodlight

FOREST는 노출형 수목 투사용 투광 조명기구로, 조경 현장에서 수목 조명이나 팩 조명 등 다양한 용도로 활용할 수 있습니다. 상향 대칭형 광원을 통해 수목 투사에 최적화된 조명을 제공하며, 제품 하부에서 간편하게 에이밍이 가능하여 조경 현장에서 탁월한 성능을 발휘합니다.

FOREST is a surface-mounted floodlight fixture designed for tree projection lighting, offering versatile applications in landscaping, such as tree illumination or pack lighting. It emits symmetrical upward light, specifically optimized for tree projection, and allows for easy aiming adjustments from the base, ensuring outstanding performance in landscaping projects.

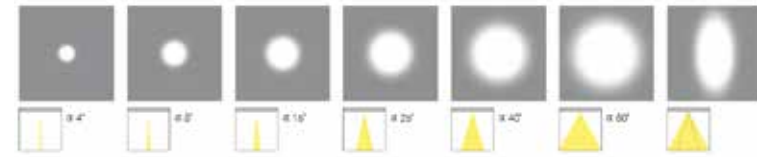
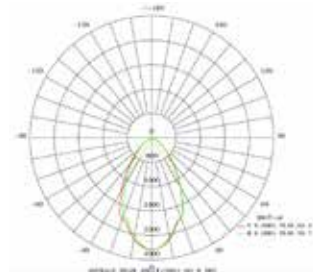

FOREST

제품의 하우징은 다이캐스팅 알루미늄으로 제작되었습니다.
제품 내부의 링구 및 부속자재는 스테인레스 스틸로 제작되었습니다.
강화유리 적용(투명 유리)
렌즈타입 제품(다양한 렌즈 적용가능)

제품 외부에서 광원부의 에이밍이 가능합니다.
제품 하단부의 렌치볼트를 사용하여 좌우로 약 15도 조절이 가능합니다.

Housing made of die-casting aluminum.
Frame ring and accessories are made of stainless steel.
Safety glass(clear type, sanding type optional)
Floodlights with Lens(Various Lens App.)

Floodlight can be tilted, light module can be tilted
-15 to 15 degree.

Finsh color : Dark grey

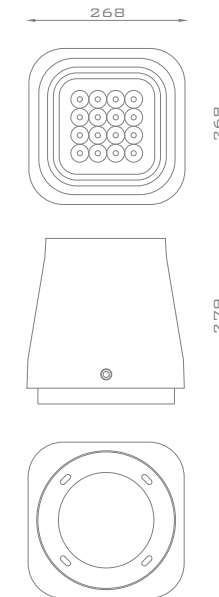

BODY : Aluminium die-casting
SIZE : W268 x D268 X H279
CRI : ≤80, 90
Lamp : LED 50W
I V : CV/CC
C T : 3000K / 4000K /
Tunable White / RGBW



ECO-F40 / ECO-F75

Surface Floodlights

ECO-F40/75는 편안함을 주는 광학기술로 설계된 스포트라이트 제품으로 다양한 렌즈 선택지를 통해 탁월한 빛 제어를 보장합니다. 이를 통해 좁은 기둥부터 넓은 면, 나무와 관목 같은 녹지 요소까지 어떤 건축 및 환경 디테일도 정밀하게 투사할 수 있습니다.

ECO-F40/75 is a spotlight, engineered with comfort optics with Spot, Medium and Flood beams that ensures exceptional light control and allows you to illuminate in a functional and precise way any architectural detail from narrow colonnades to large faces to any element of the green, from trees to bushes.



ECO-F40 / ECO-F75

제품의 바디 다이캐스팅 알루미늄으로 제작되었습니다.
강화유리 적용
렌즈타입 제품(4°, 15°, 25°, 40°, 60°)

제품 좌우측 렌치볼트로 간편하게 각도 조절이 가능합니다.
제품에 허니컴루버, 스펀링 등이 적용가능합니다.

Body made of die-casting aluminum.
Safety glass
Floodlights with Lens(4°, 15°, 25°, 40°, 60°)

Floodlight can be tilted.
Honeycomb louver and Spill ring can be applied.
Finish color : Dark grey

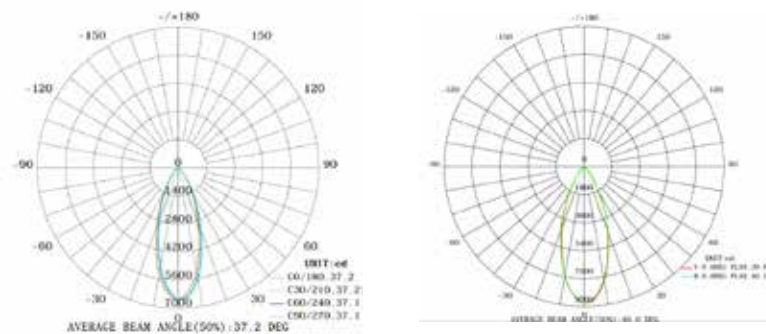
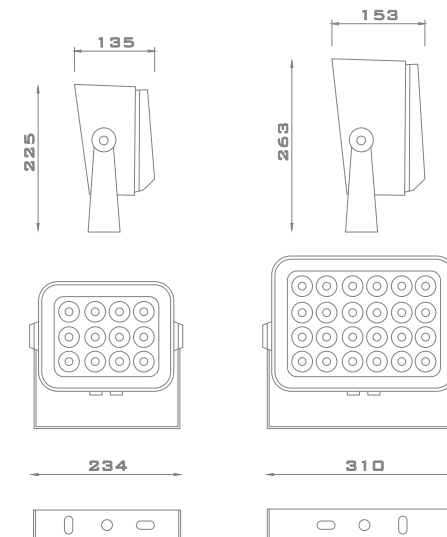

40W Louver Type



75W Normal Type

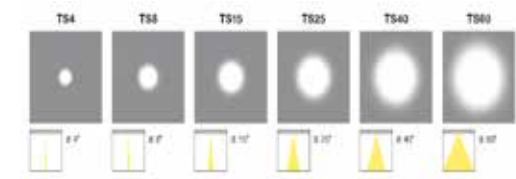

BODY Aluminium die-casting
SIZE : W234 x D135 x H225
W310 X D153 X H263
CRI : ≤90
Lamp : LED 40W / 75W
I V : Constant Current
C T : 3000K / 4000K / TW / RGBW



ECO-F15 / ECO-F25

Surface Floodlights

ECO-F15/25는 편안함을 주는 광학기술로 설계된 스포트라이트 제품으로 다양한 렌즈 선택지를 통해 탁월한 빛 제어를 보장합니다. 이를 통해 좁은 기둥부터 넓은 면, 나무와 관목 같은 녹지 요소까지 어떤 건축 및 환경 디테일도 정밀하게 투사할 수 있습니다.

ECO-F15/25 is a spotlight, engineered with comfort optics with Spot, Medium and Flood beams that ensures exceptional light control and allows you to illuminate in a functional and precise way any architectural detail from narrow colonnades to large faces to any element of the green, from trees to bushes.



ECO-F15 / ECO-F25

제품의 바디 다이캐스팅 알루미늄으로 제작되었습니다.
강화유리 적용
렌즈타입 제품(15°, 25°, 40°, 60°)

제품 좌우측 렌치볼트로 간편하게 각도 조절이 가능합니다.
제품에 허니컴루버, 스피링 등이 적용가능합니다.

Body made of die-casting aluminum.
Safety glass
Floodlights with Lens(15, 25, 40, 60)

Floodlight can be tilted.
Honeycomb louver and Spill ring can be applied.
Finish color : Dark grey

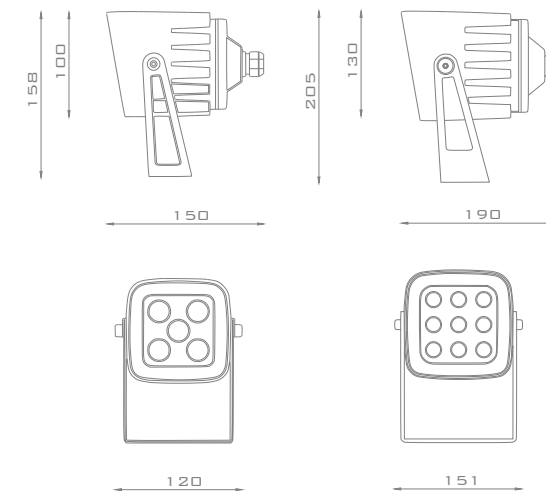

25W Type



15W Type

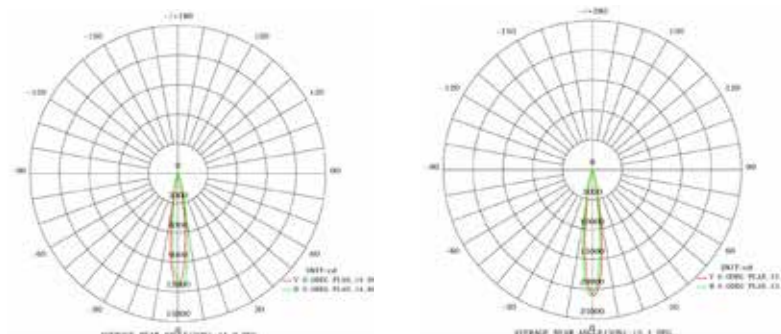
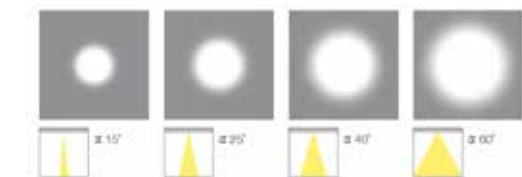

BODY : Aluminium die-casting
SIZE : W151 x D190 x H205
W120 X D150 X H158
CRI : ≤90
Lamp : LED 15W / 25W
I V : Constant Voltage
C T : 3000K / 4000K



WRINKLE II

Compact LED surface floodlights



Wrinkle II 제품은 컴팩트한 LED 투광기 제품으로 정원용 투광등, 식생, 건축물의 세부 투광기 등으로 사용 가능합니다. 다양한 용도로 경제적이고 내구성 있는 제품으로 현장 여건에 따라 블루투스를 통한 제어 또한 가능합니다.

Wrinkle One is Compact LED garden floodlights for varying uses such as objects, gardens, plants or building details. It is Cost-effective and durable luminaires thanks to ECO LED technology, it can be also optionally controlled by Bluetooth.

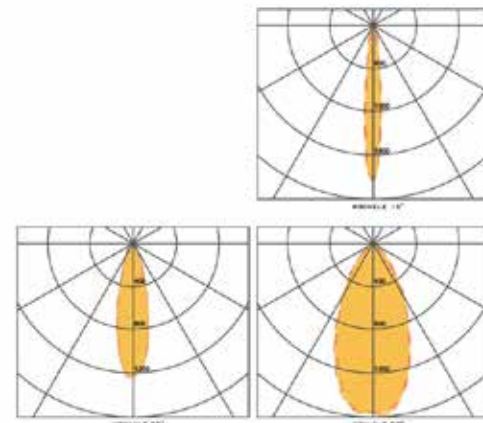

Compact LED floodlights

제품의 바디와 SMPS 박스는 알루미늄으로 제작되었습니다.
강화유리 적용(투명 유리) 반사판 적용한 투광 타입(15°, 25°, 50°)

광원부는 각도 조절이 가능합니다.
0°에서 90° 조절이 자유롭게 가능합니다.

Lumina ires housing and SMPS box are made of aluminum.
Safety glass(clear type)
Floodlights with reflector(15°, 25°, 50°)
Hood available.

Floodlight is easily tiltable
from 0° to 90° degree as above.

Lens option : 15°, 25°, 50°
Finish color : Dark grey, on demand.

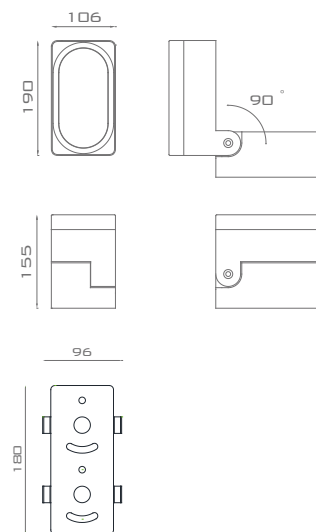
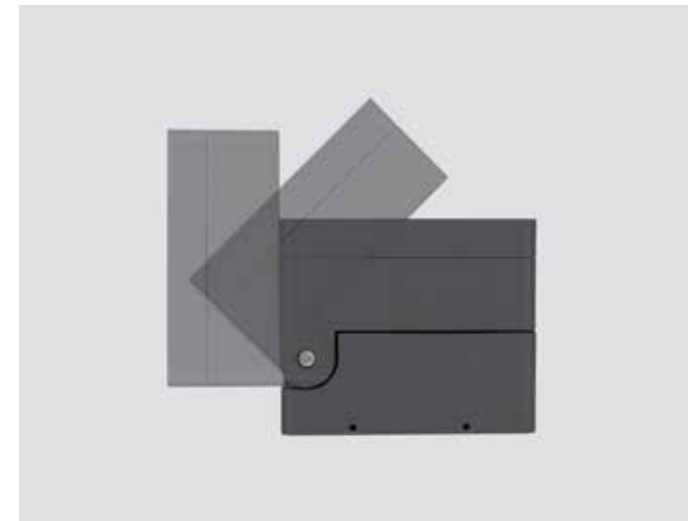

BODY : Aluminium die-casting
SIZE : W106 x L190 x H155
CRI : ≤90
Lamp : LED 50W
I V : Constant Current
C T : 3000K, 4000K, RGBW



HORUS

LED high-performance floodlights



HORUS는 고성능 투광기로 많은 양의 빛을 필요로 하는 현장에 적용됩니다. 직사각의 컴팩트한 디자인에 강력한 성능으로 최대 90W 급의 성능을 가지고 있습니다. 경제성과 강력한 성능을 모두 충족시킬 수 있는 제품입니다.

HORUS is a high-performance floodlights. With a rectangular compact design and a luminaire luminous flux of maximum 40000lm(90W), this series meets both economic ends and performance ends.

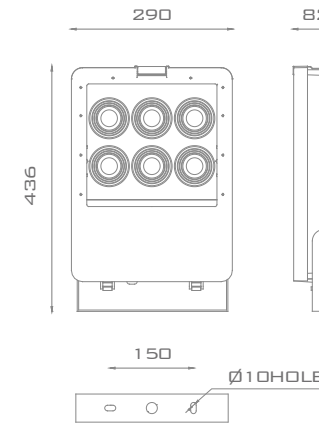
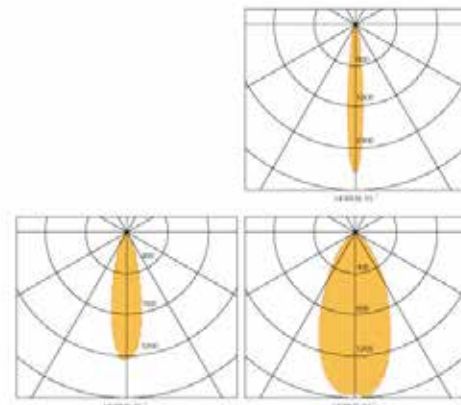

HORUS

제품의 하우징은 다이캐스팅 알루미늄으로 제작되었습니다.
 제품 내부의 링구 및 부속자재는 스테인레스 스틸로 제작되었습니다.
 강화유리 적용(투명 유리) 반사판 적용한 투광 타입(대칭 타입 15°, 25°, 50°)
 광원부는 각도 조절이 가능합니다. 현장 여건에 맞게 상하 180° 조절이 가능합니다.

Housing made of die-casting aluminum. Frame ring and accessories are made of stainless steel.
 Safety glass(clear type) Floodlights with reflector(Symmetrical 15°, 25°, 50°)

Flood light can be tilted, each module can rotate up and down easily from 0° to 180° degree.

Finish color : Dark grey, on demand.

- BODY : Aluminium die-casting
- SIZE : W290 x L436 x D82
- CRI : ≤90
- Lamp : LED 90W
- I V : Constant Current
- C V : 3000K, 4000K, RGB



FREEBEND 500H , 750H

Free bending flexible floodlights



FREEBEND 500H, 750H는 조경현장의 수목투사에 적합한 제품입니다.

제품은 스테인레스스틸 외함으로 구성되어 있으며, 현장에 적합한 지름 값으로 설정되어, 최적의 제품 투광을 가능하게 합니다.

제품의 광원부는 실리콘 몰딩 프로세스를 거쳐 소금, 산, 알칼리에 대해 강하고, 자외선에도 강한 제품입니다. 또한 다양한 각도의 렌즈 옵션을 가지고 있습니다.

FREEBEND 500H, 750H are perfect for outdoor tree lighting as they provide the proper diameter for each outdoor site.

They were produced by an intergrated extrusion molding process, have a waterproof rating up to IP65 and feature a patented optical structure design with a variety of angles optional.

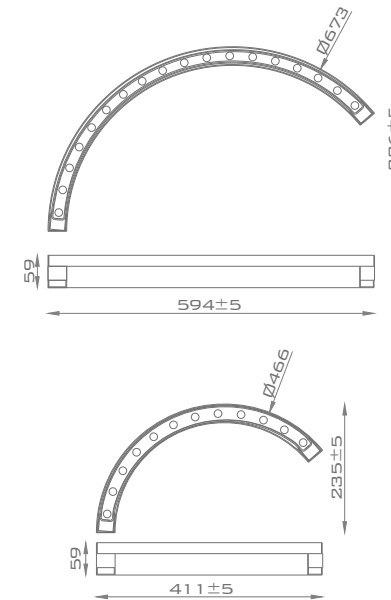

FREEBEND

제품의 바디는 스테인레스스틸로 제작되었습니다.

밴딩 내경은 최소 400mm입니다.

제품 커팅 사이즈에 따른 (500,750) 광량 및 길이 값이 상기 도면과 같습니다.

*제품에 대한 배광 약세사리 설치방법 결선 등 자세한 정보는 영업부에 별도 카달로그 요청바랍니다.

Luminaire's body is made of silicone.
minimum bending diameter is 400mm

For more details please request 'Freebend Catalouge'

Lens option : 15°, 30°, 50°, Wall-washers

Finsh color : Grey

BODY : Stainless steel
CRI : ≤80
Lamp : LED 15W(500), 20W(750)
I V : Constant Voltage
C T : MONO, RGBW



PEAK

Outdoor ground spotlight - 15W

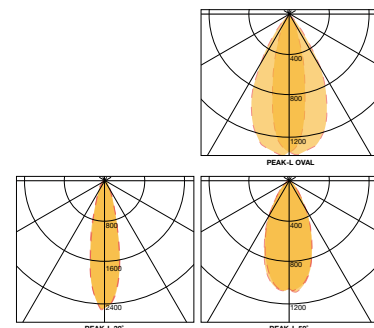

PEAK 제품은 상대적으로 작은 제품이지만 신뢰성 있는 빛을 생산하며 조경 현장의 소규모 관목에 적용 가능합니다. 제품의 회전 포인트는 고정된 제품의 스파이크에서 헤드를 회전시킵니다. 이를 통해서 변화 가능한 다양한 빛을 만들어냅니다. 또한, 글레어 방지를 위한 다양한 액세서리 적용이 가능합니다.

This tiny PEKA-L produce reliable light which can be perfectly applied to garden and small size trees. The swivel point tilts the whole head over the ground spike, making the luminaires' light variable. It can be also combined with accessories that can prevent glare.

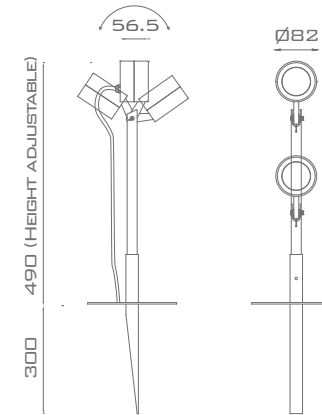

Outdoor ground spotlight

제품의 바디는 알루미늄으로 제작되었습니다.
강화유리 적용(투명 유리) 렌즈타입 (Oval, 20°, 60°)
SMPS 내장/외장형 후드장착

광원부는 각도 조절이 가능합니다.
0° 에서 180° 조절이 자유롭게 가능합니다.

Luminaires housing and SMPS box are made of aluminum.
Safety glass(clear type)
Floodlights with LENS (Oval, 20°, 60°)
SMPS BOX Inside(Optional)

Floodlight is easily tiltable
from 0 to 180 degree as above.

Lens option : Oval, 20°, 60°
Finish color : Dark grey, on demand.

BODY : Aluminium die-casting
SIZE : Ø82 x L56.5 X H790
CRI : ≤90
Lamp : LED 10W, 15W
I V : Constant Current, AC Drive
C T : 3000K, 4000K



HEAD ONLY

PEAK-360

Outdoor ground spotlight - 15W
360° ROTATE-FREE



PEAK-360 제품은 상대적으로 작은 제품이지만 신뢰성 있는 빛을 생산하며 조경현장의 소규모 관목에 적용 가능합니다.
제품의 볼 헤드 구조는 제품의 360도 회전이 가능합니다.
이를 통해서 연출적인 한계를 극복하고 매우 극적인 빛 연출을 만들어 냅니다.
또한, 글레어 방지를 위한 다양한 액세서리와 결합되어 생산됩니다.

This tiny PEKA-360 produce reliable light which can be perfectly applied to garden and small size trees.
The ball joint structure of the product makes it 360 degree rotate free possible which can achieve dramatic light aiming.
It can be also combined with accessories that can prevent glare.

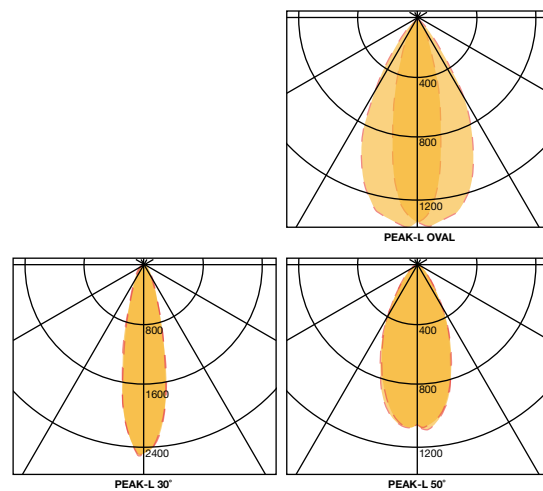

Outdoor ground spotlight

제품의 바디는 알루미늄으로 제작되었습니다.
강화유리 적용(투명 유리)
반사판 적용한 투광 타입(Oval, 20° , 60°)
SMPS 내장/외장형
후드 장착

광원부는 각도 조절이 가능합니다.
0°에서 360° 조절이 자유롭게 가능합니다.

Luminaire housing and SMPS box are made of aluminum.
Safety glass(clear type)
Floodlights with reflector(Oval, 20° , 60°)
SMPS BOX Inside(Optional)

Floodlight is easily tiltable
from 0 to 360 degree as above.

Lens option : Oval, 20° , 60°
Finish color : Dark grey, on demand.

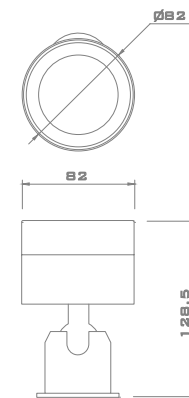
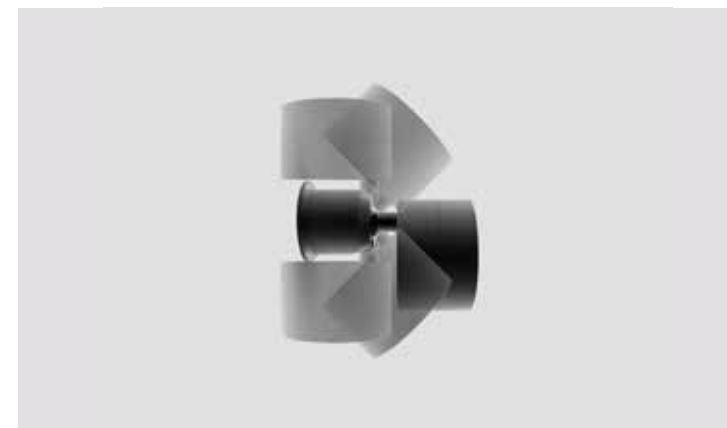

BODY : Aluminium die-casting
SIZE : $\Phi 82 \times H 128.5$
CRI : $\leq 90 / \leq 96$
Lamp : LED 10W, 15W
I V : Constant Current, AC Drive
C T : 3000K, 4000K





Pole luminaires
Multi-functional Pole

FL-35

Pole luminaires

FL35는 고효율의 LED 가로등으로 대칭형의 배광을 가지고 있는 제품입니다.

제품은 낮에는 도시 디자인의 심미성을 높여주고, 밤에는 신뢰성 있는 빛을 제공합니다.

제품의 배광 및 빛의 통일성의 측면을 살펴볼 때 공원, 주거지, 주차장 등의 공간에 적합한 제품입니다.

FL35 is cost-efficient LED pole luminaires with symmetrical flat beam light distribution.

The products' appearance accentuates urban design by day while at night it creates a reliable light environment.

A luminaire concept whose light distribution, uniformity of light and energy efficiency are ideal for the illumination of park, residential streets, parking spaces and traffic-calmed areas.

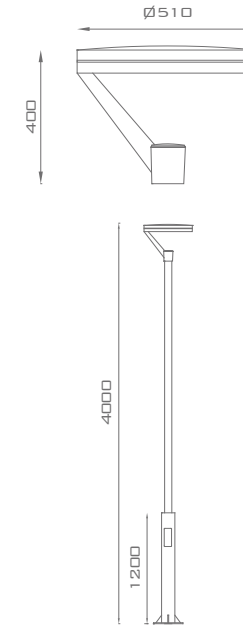
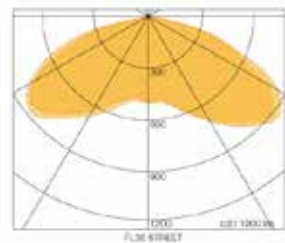

LED Pole luminaires

제품의 바디는 알루미늄으로 제작되었습니다.

제품 2단 폴은 스테인레스 스틸로 제작되었습니다.

강화유리 적용(투명 유리)

반사판 적용 가능한 평판 PCB 타입(비대칭 LENS 적용)

Luminaires housing and pole are made of aluminum.

Pole is made of stainless steel.

Safety glass(clear type)

High flux LEDs mounted to PC boards(ASY LENS)

Finish color : Dark grey, on demand.

- BODY : Aluminium die-casting
- SIZE : $\Phi 510 \times H4,000$ (Optional)
- CRI : ≤ 90
- Lamp : LED 30W / 50W
- I V : Constant Current
Constant Voltage
- C T : 3000K, 4000K



HEAD ONLY

PL-40

Pole luminaires

PL-40은 고효율의 LED 가로등으로 도심환경에 적합한 제품입니다.

제품은 현장 여건에 따라 2개 또는 3개의 LED 모듈(일반/D4i 모듈)을 장착하여 사용됩니다.
고성능의 옵틱과 에너지 절감을 가능하게 하는 D4i 모듈과 컨버터를 추가로 장착할 수 있어,
공공 조명의 친환경적 관리를 가능하게 합니다.

PL-40 is designed for the urban environment, ideal for any context. Installed as pole mounted using a "collar"
pole connection is available in the 2 LED modules version and 3 LED modules for parking and street lighting.
It has high-performing optics and is compatible for an eco-sustainable management of the public lighting.

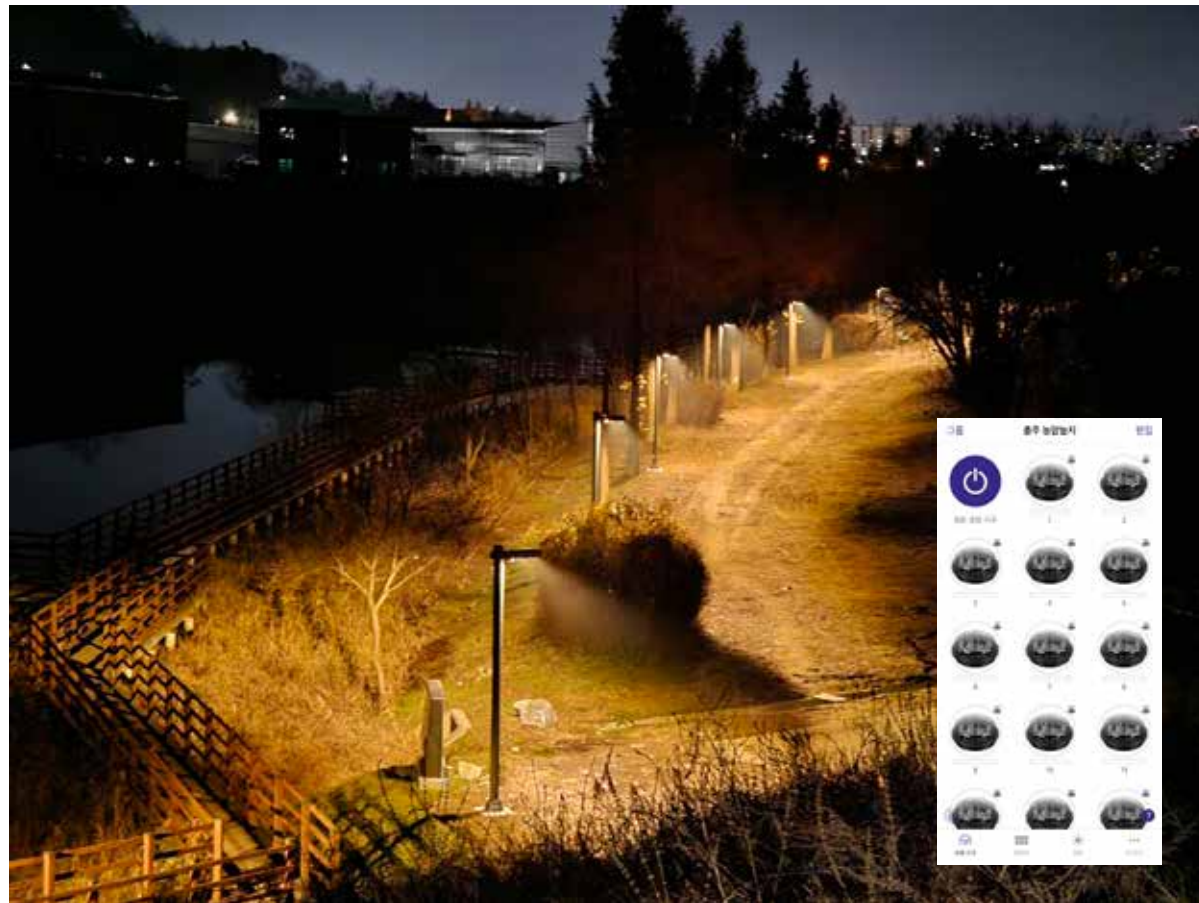

D4i APP. Site

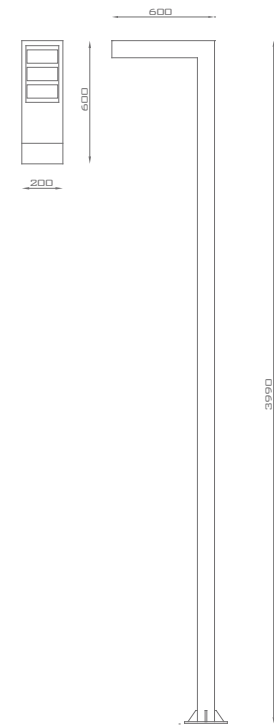

LED Pole luminaires

제품의 프레임 및 바디는 용융도금 철로 제작되었습니다.
내부 브라켓 및 부속 철물들은 용융도금 철로 제작되었습니다.
PCB, 렌즈, 방열판 일체형 모듈 사용(일반형/D4i 타입)
*자세한 자료는 영업부에 문의 바랍니다.

Luminaires housing and pole
are made of galvanized steel.
Bracket and accessories are made of galvanized steel
High flux LEDs Modules(normal / D4i type)
SMPS Built-in

Finish color : Dark grey, Dark brown on demand.

BODY : Hot dipped Galvanized Iron
SIZE : W600 x D200 X H4,000(Optional)
CRI : ≤80(≤90)
Lamp : LED 40W / 60W
I V : Constant Current
Constant Voltage
C T : 3000K, 4000K

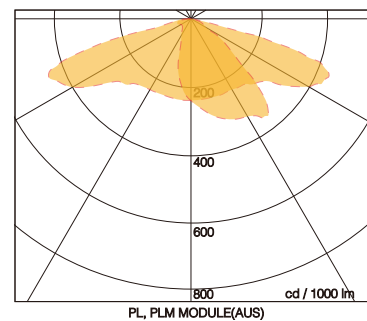

PLM-60

Pole luminaires

PLM-60은 고효율의 LED 가로등으로 도심환경에 적합한 제품입니다.

제품은 기둥부에 설치되어 2개 또는 3개의 LED 모듈(일반/D4i모듈)을 장착하여 사용됩니다.
고성능의 옵틱과 에너지 절감을 가능하게 하는 D4i 모듈과 컨버터를 추가로 장착할 수 있어,
공공 조명의 친환경적 관리를 가능하게 합니다.

PLM-60 is designed for the urban environment, ideal for any context. Installed as pole mounted using a "collar"
pole connection is available in the 2 LED modules version and 3 LED modules for parking and street lighting.
It has high-performing optics and is compatible for an eco-sustainable management of the public lighting.
The light emission is completely directed downwards for a performant lighting distribution which can reach an interdistance
of even four times the height of its installation.

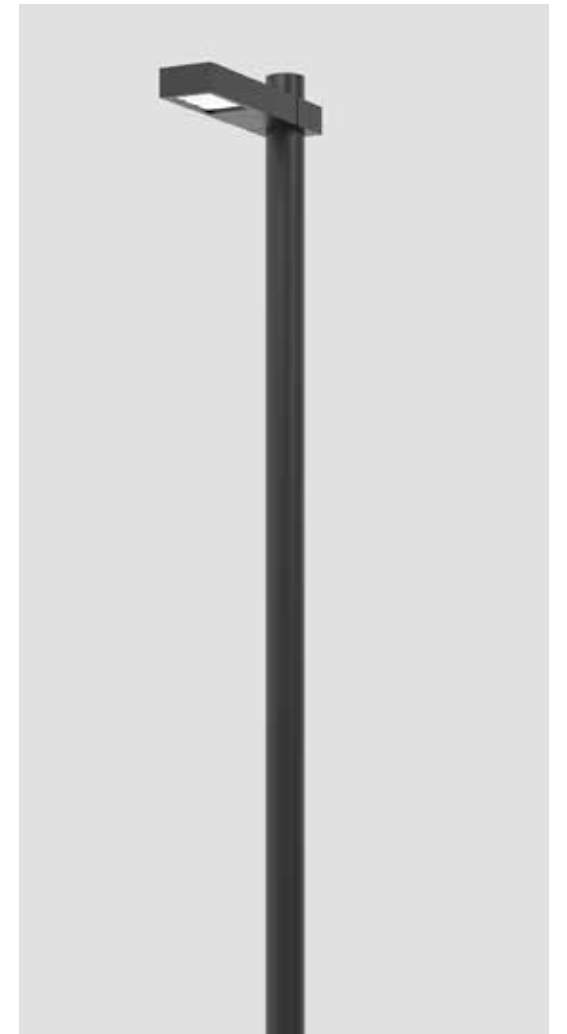
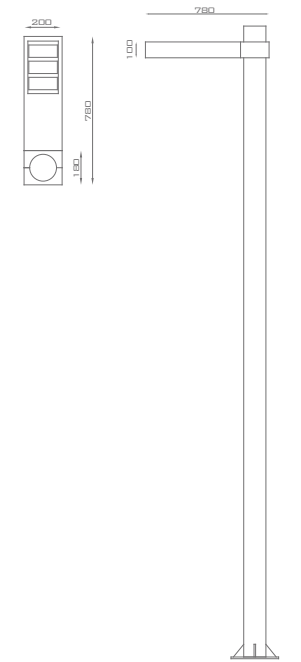
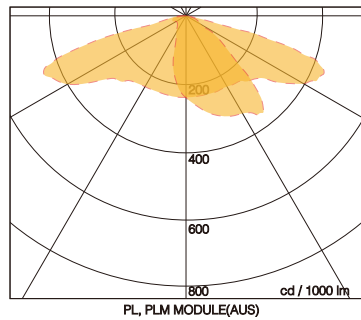

LED Pole luminaires

제품의 폴은 용융도금 철로 제작되었습니다.
내부 브라켓 및 부속 철물들은 스테인레스로 제작되었습니다.
PCB, 렌즈, 방열판 일체형 모듈 사용(일반형/D4i 타입)
*자세한 자료는 영업부에 문의 바랍니다.

Luminaires pole is made of galvanized steel.
Bracket and accesories are made of stainless steel
High flux LEDs Modules(normal / D4i type)
SMPS Built-in

Finish color : Dark grey, Dark brown on demand.

BODY : Stainless steel
SIZE : W780 x D200 X H4,000(Optional)
CRI : ≤80(≤90)
Lamp : LED 40W / 60W
I V : Constant Current
Constant Voltage
C T : 3000K, 4000K



VERTICAL 4000

360° Urban design pole

VERTICAL 4000은 수직적인 빛을 360도로 분산시키는 제품입니다.

제품은 이중구조의 폴리카보네이트로 구성되어 UV 및 충격에 강하며 전체 높이에서 균일한 빛 분포를 보장합니다. 제품은 도시 경관 요소에 필수적인 최소의 디자인과 최대의 조명 효과를 위해서 만들어진 제품입니다.

VERTICAL 4000 provides a vertical and diffused light, not directed exclusively downwards.

The polycarbonate diffuser is UV and impact resistant and guarantees a uniform light distribution throughout its whole height.

VERTICAL 4000 is suitable for creating ambient lighting effects particularly appropriate in urban and landscape applications.

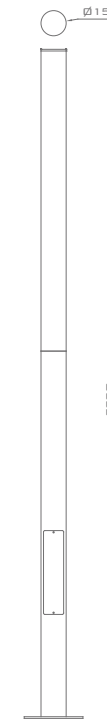
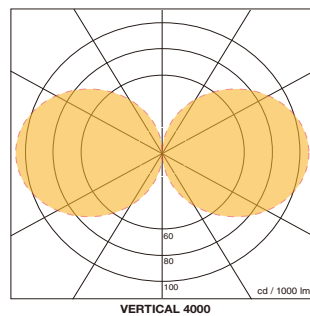

LED Pole luminaires

제품의 바디는 알루미늄으로 제작되었습니다.
제품의 폴은 스테인레스 스틸로 제작되었습니다.
2중 폴리카보네이트 적용 (투명/불투명)
SMPS 내장형

Luminaires housing is made of aluminium
Pole is made of stainless steel.
Polycarbonate(clear type/translucent type)
SMPS Built-in

Finish color : Dark grey, Dark brown on demand.

BODY : Aluminium die-casting
SIZE : $\varnothing 150, 152.4 \times H4,000$ (Optional)
CRI : ≤ 90
Lamp : LED 86W(MONO)
I V : Constant Current
C T : 3000K, 4000K, RGBW, TW

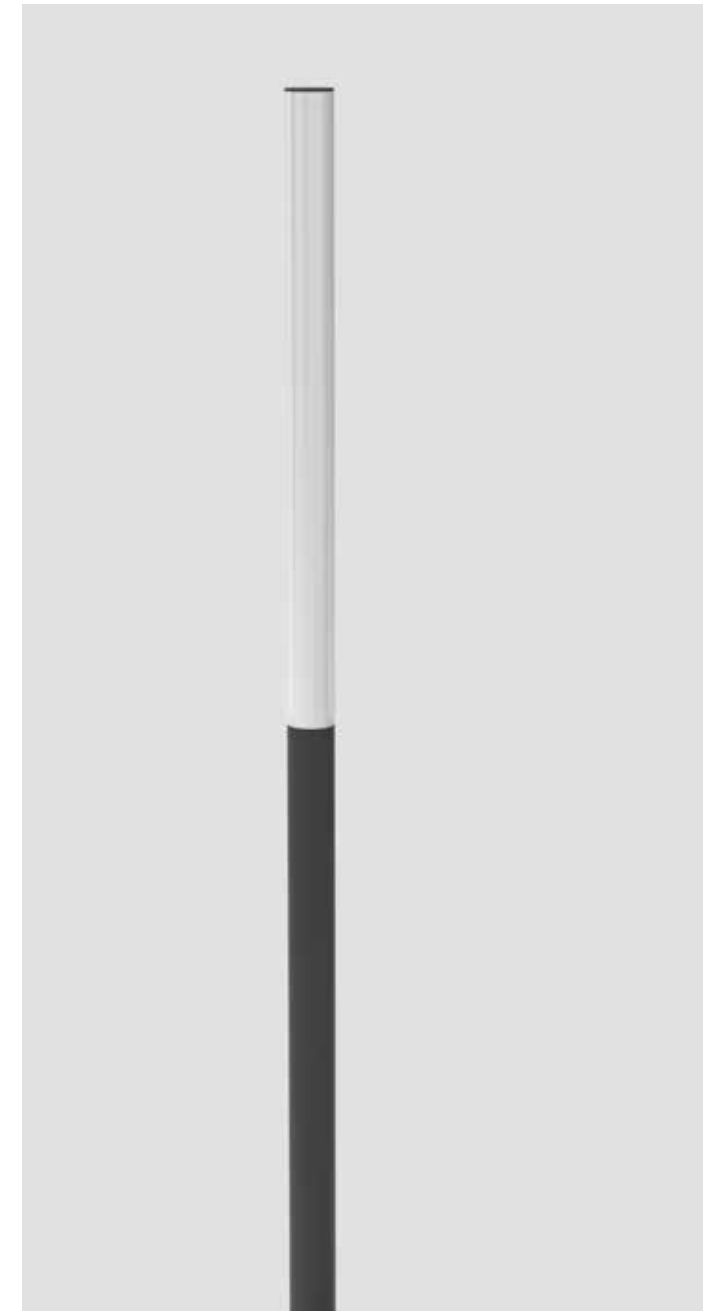

PL101

360° Urban design pole

PL101은 도시 경관 조명에서 경관 요소에 필수적인 최소의 디자인과 최대의 조명 효과를 위해서 만들어진 제품입니다. 제품 상부의 광원, 지지대 구조, 투명 PC로 구성되어 간결하면서도 인상적인 효과를 연출합니다.

PL101 is a product designed for urban landscape lighting, combining minimal design with maximum lighting effects to highlight essential landscape elements. The product features a light source on the upper section, along with a supporting rod structure made of transparent PC, delivering a simple yet striking visual effect.

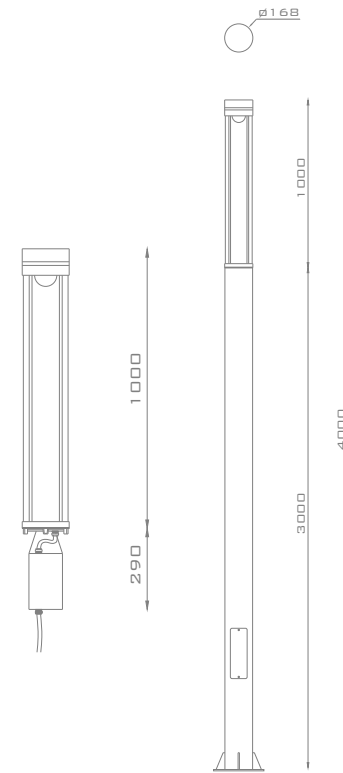
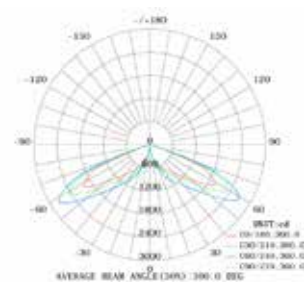

LED Pole luminaires

제품의 바디는 다이캐스팅 알루미늄으로 제작되었습니다.
제품의 폴은 용융도금 폴로 제작되었습니다.
단일 폴리카보네이트 적용 (투명)
SMPS 내장형

Luminaires housing is made of aluminium
Pole is made of hotdip galvanized steel.
Polycarbonate(clear type)
SMPS Built-in

Finish color : Dark grey

BODY : Aluminium die-casting
SIZE : $\Phi 168 \times H4,000$ (Optional)
CRI : $\leq 80,90$
Lamp : LED 50W(MONO)
I V : Constant Current
C T : 3000K, 4000K

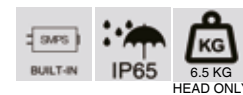

PL102

360° Urban design pole

PL102은 수직적인 빛을 360도로 분산시키는 제품입니다.

제품은 디퓨저 내부에 루버구조를 넣어 글레어를 효과적으로 감소시키고 디자인적으로도 더욱 세련된 형태의 제품입니다. 글레어를 최소화하면서도 신뢰성있는 빛을 제공합니다.

PL102 is a product that disperses vertical light in a 360-degree manner.

The product incorporates a louver structure within the diffuser, effectively reducing glare while offering a more sophisticated design. It provides reliable lighting while minimizing glare to ensure optimal performance.

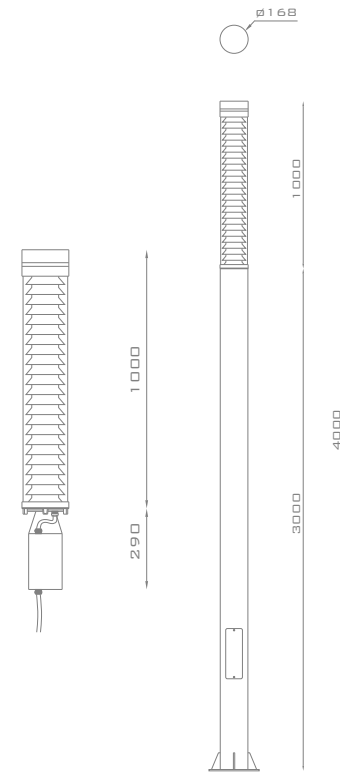
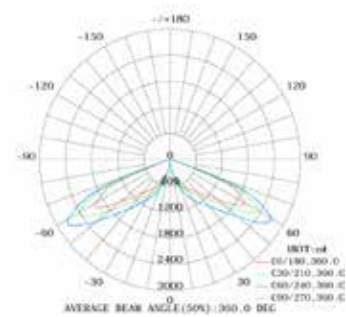
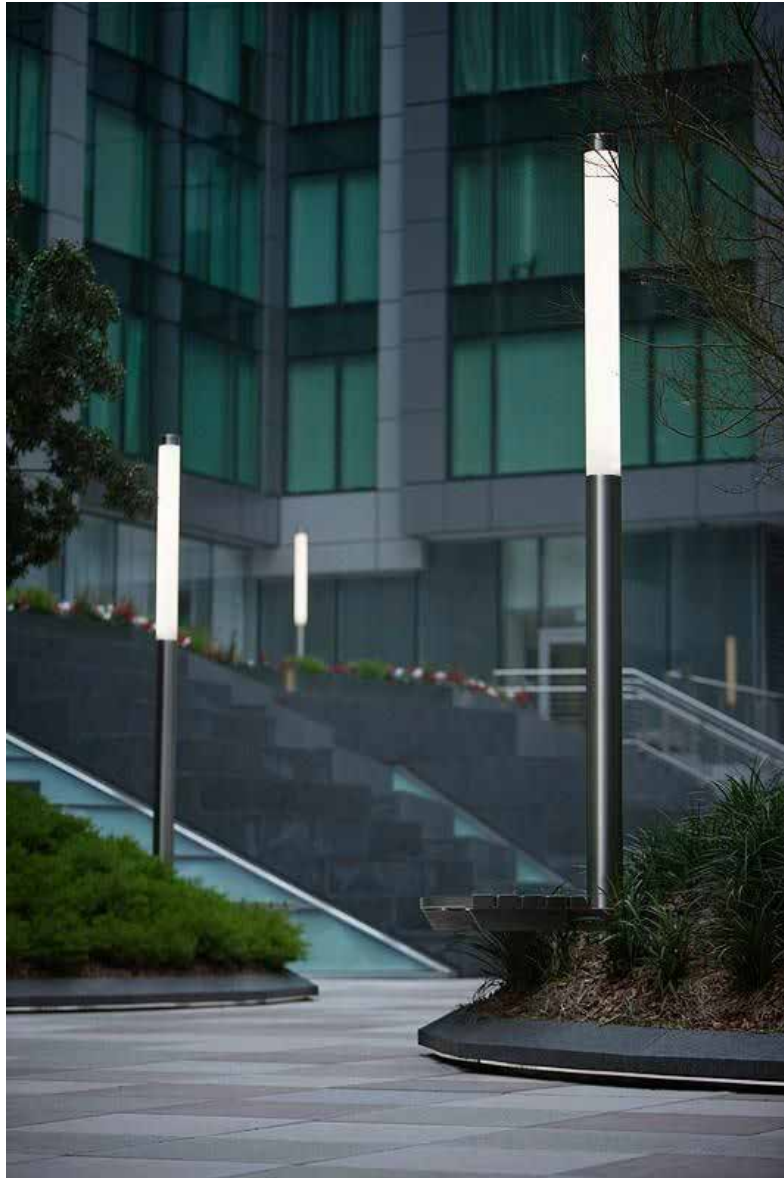

LED Pole luminaires

제품의 바디는 다이캐스팅 알루미늄으로 제작되었습니다.
 제품의 폴은 용융도금 폴로 제작되었습니다.
 단일 폴리카보네이트 적용 (투명)
 SMPS 내장형

Luminaires housing is made of aluminium
 Pole is made of hotdip galvanized steel.
 Polycarbonate(clear type)
 SMPS Built-in

Finish color : Dark grey

BODY : Aluminium die-casting
 SIZE : $\Phi 168 \times H4,000$ (Optional)
 CRI : $\leq 80,90$
 Lamp : LED 60W(MONO)
 I V : Constant Current
 C T : 3000K, 4000K



WRINKLE MP

Versatile Floodlights installed on a pole

PRISM MP는 명료성과 다재다능한 특성으로 다양한 도시환경 및 건축환경에 적용이 가능한 제품입니다.
다양한 부속 철물과 결합하여 폴, 벽, 지면 등의 다양한 적용이 가능합니다.
현장 여건에 따라 1개부터 여러개의 제품을 폴에 적용하여 적합한 솔루션을 제공합니다.

Prism MP has clarity and versatility and it makes a fabulous lighting system for almost any type of urban and architectural space. Available in different sizes and with a wide range of accessories to be installed including pole mounting.

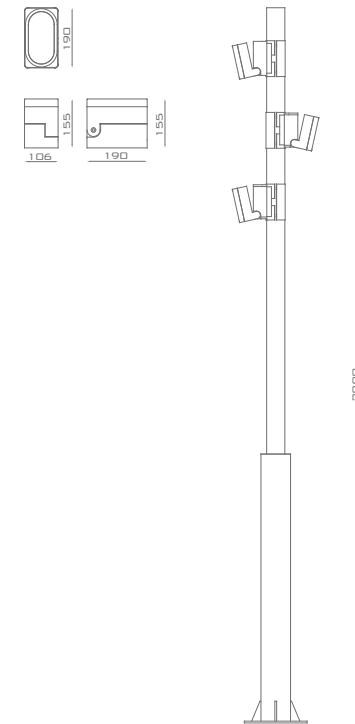

LED Pole luminaires

제품의 바디는 알루미늄으로 제작되었습니다.
제품의 폴은 스테인레스스틸로 제작되었습니다.
내부 브라켓 및 부속 철물들은 스테인레스 스틸로 제작되었습니다.
강화유리 적용(투명 유리)
반사판 적용 가능한 평판 PCB 타입(ASY LENS APP.)
SMPS 내장형

Luminaires housing and pole are made of aluminum.
Bracket and accessories are made of stainless steel.
SMPS Built-in

Finish color : Dark grey, Dark brown on demand.

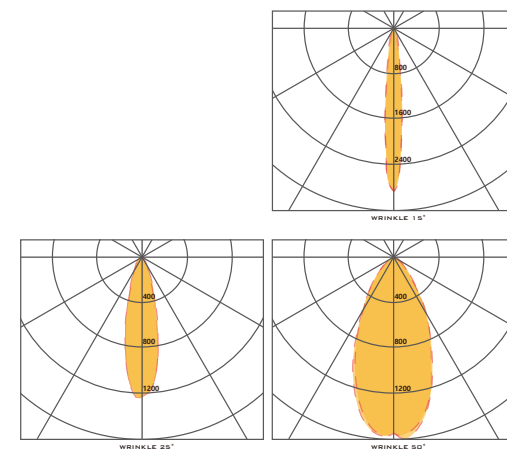

BODY : Aluminium die-casting
SIZE : $\Phi 102 \times H4,000$ (Optional)
CRI : ≤ 90
Lamp : LED 50W / 100W / 150W
I V : Constant Current
C T : 3000K, 4000K, RGBW



MP190

Multi functional pole for urban public design.



MP190은 단순한 등 기구 이상으로, 도시 야외 환경에 기술과 편리성을 더합니다. 조명기구의 기능과 더불어 CCTV, 비상벨, 스피커 등의 다양한 시설물을 결합 시킵니다. MP190은 다양한 형태의 도시환경 조명에 특화되어 있습니다. 보안등 모듈, 건물을 위한 투광 모듈, 조경용 투광 모듈, 볼라드 모듈 등을 통해, 목표하는 도시환경에 적합한 LIGHT-SOLUTION을 제공합니다. 제품의 특이점으로, 회전 가능한 제품별 모듈을 현장에서 클램핑하여, 연출을 자유롭게 진행할 수 있습니다.

MP190 is much more than a luminaire, it brings added technologies to outdoor urban spaces. It integrates features such as loudspeakers, CCTV cameras, intercoms. Available with a range of smart lighting modules, MP190 can provide solutions adapted to any type of urban landscape. It has pole luminaires, floodlights for façades, floodlights for trees and garden, Bollards modules. Our rotatable modules and clamp make the direction of light and aiming possible to be adapted precisely on-site.

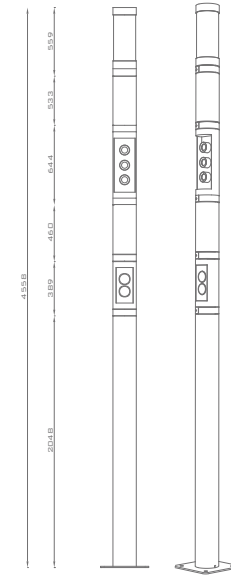

Multi functional pole MP190

제품은 ø 190의 모듈의 적층 구조로 구성됩니다.

조명기구의 구성으로는 보안 등 모듈, 투광기 모듈(파사드 투광), 투광기 모듈(수목 투광형), 볼라드 모듈이 있습니다.

모듈의 구성으로는 CCTV, 비상벨 모듈, 스피커 모듈이 있습니다.

우측 편과 같은 모듈 조화가 가능하며, 자세한 내용은 후면 95p 상세 정보란을 참조하시기 바랍니다.

MP190 is consist of Pie190 Horizontally additive modules.

Lighting Modules : Pole luminaires, Floodlights for façades, Floodlights for garden.

Urban Environment Modules : CCTV, Intercom, Loudspeaker
Each floodlight are adjustable, each module can rotate easily from 0 to 360 degree.

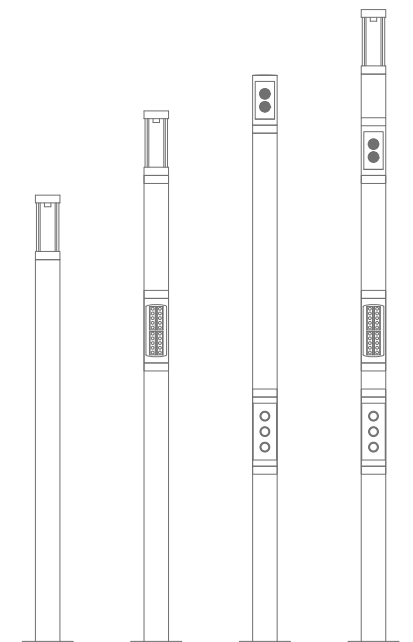



MP190 Pole luminaires / 보안등 모듈

BODY : Aluminium die-casting
 SIZE : PIE190 x 490
 CRI : ≤90
 Lamp : LED 40W
 I V : Constant Current

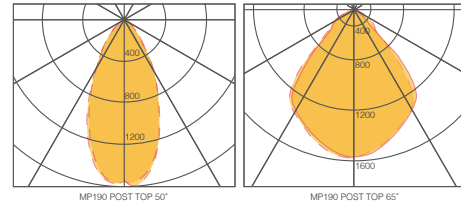

CCTV Module / 보안카메라 모듈

CCTV모듈은 현장여건에 따른 제품으로 대응이 가능합니다.

BODY : Aluminium die-casting
 SIZE : PIE190 x 400
 CAMERA : On request(동형, 부착형)



Floodlights for façade / 건축용투광등 모듈

BODY : Aluminium die-casting
 SIZE : PIE190 x 560
 CRI : ≤90
 Lamp : LED 40W
 I V : Constant Current

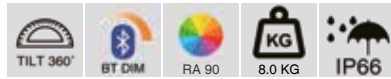
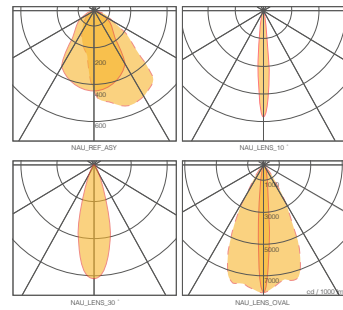

Loudspeaker Modules / 스피커 모듈

BODY : Aluminium die-casting
 SIZE : PIE190 x 385
 Transformer matching : 12W
 Sound pressure level : 89dB (1W/1m) @3200Hz
 Frequency response : 160Hz to 16000Hz
 Mean sound pre. level : 82dB
 Opening angle : (-6dB) 40°/4000Hz long axis
 Opening angle : (-6dB) 50°/4000Hz shrot axis
 Length feed cable : 6m
 Temperature range : -40 ... 80°C



Floodlights for garden / 보안등 모듈

BODY : Aluminium die-casting
 SIZE : PIE190 x 530
 CRI : ≤90
 Lamp : LED 20W x 3
 I V : Constant Current

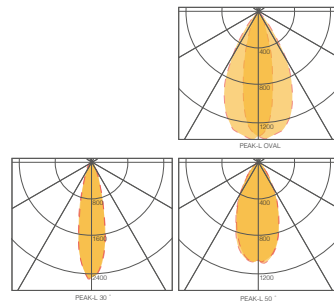

MP190 Intercom module / 비상벨 모듈

BODY : Aluminium die-casting
 SIZE : PIE190 x 710
 OP : Vandal resistant SIP and IP intercom
 Clear audio sound (active noise cancellation)
 Stainless steel front plate with on button



SL-40

Pole luminaires

SL-40은 투명 또는 반투명의 커버가 장착된 LED 가로등으로 대칭적이고 균일하고 부드러운 빛 분배를 특징으로 합니다. 기구의 특성상 공원 및 주거공간 그리고 주차장 등 교통이 혼잡하지 않은 구역에 적합한 조명기구입니다.

SL-40 is cost-efficient LED pole luminaires with symmetrical flat beam light distribution.

The products' appearance accentuates urban design by day while at night it creates a reliable light environment.

A luminaire concept whose light distribution, uniformity of light and energy efficiency are ideal for the illumination of park, residential streets, parking spaces and traffic-calmed areas.

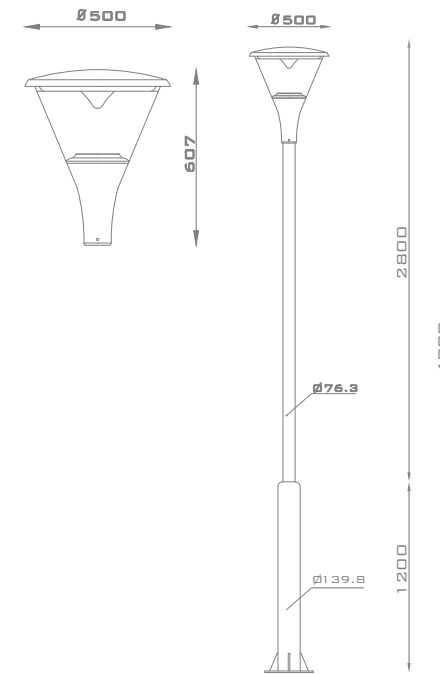

LED Pole luminaires

제품의 바디는 다이캐스팅 알루미늄으로 제작되었습니다.
제품 폴은 용융도금 철로 제작되었습니다.
UV저항 투명PC 적용(투명 타입)
SMPS 내장형

Luminaires housing is made of Die-cast aluminum.
Pole is made of steel.
UV resistant high transmittance PC cover(Clear)
SMPS Built-in

Finish color : RAL 9007, Dark grey

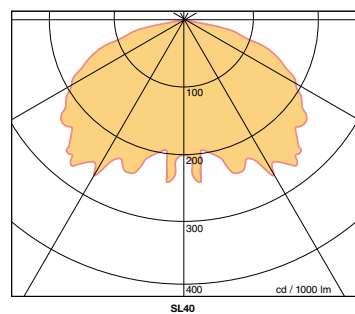

BODY : Aluminium die-casting
SIZE : Φ 500 x H4,000(Optional)
CRI : \leq 80
Lamp : LED 40, 60W(3750-6800LM)
I V : Constant Voltage
C T : 2700K, 3000K, 4000K, AMBER



BL-40

Pole luminaires

BL40은 고효율의 LED 보안등으로 대칭형의 배광을 가지고 있는 제품입니다.

제품은 낮에는 고전적인 디자인으로 심미성을 높여주고, 밤에는 신뢰성 있는 빛을 제공합니다.

제품의 배광 및 빛의 통일성의 측면을 살펴볼 때 공원, 주거지, 오피스 등의 공간에 적합한 제품입니다.

BL40 is cost-efficient LED pole luminaires with symmetrical flat beam light distribution.

The products' appearance accentuates urban design by day while at night it creates a reliable light environment.

A luminaire concept whose light distribution, uniformity of light and energy efficiency are ideal for the illumination of park, residential streets, parking spaces and traffic-calmed areas.

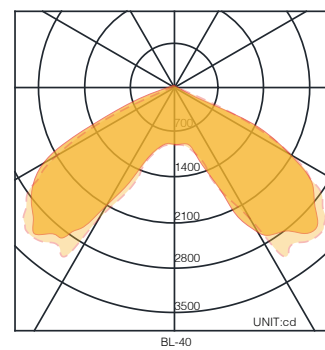
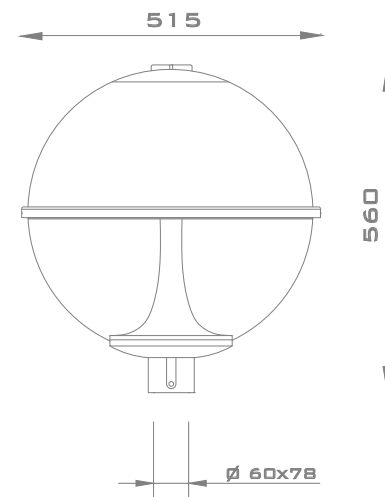

LED Pole luminaires

제품의 바디는 다이캐스팅알루미늄으로 제작되었습니다.

제품 2단 폴은 용융도금 스틸로 제작되었습니다.

폴리카보네이트 디퓨저 적용(투명PC)

Die-casting aluminium body, PC transparent diffuser.

Optics with PC lens

Surface anti-ultraviolet pure polyester power painting.

Installation pipe diameter : Φ 60

BODY : Aluminium die-casting

SIZE : Φ 515 x H4,000(Optional)

CRI : \leq 80

Lamp : LED 40W 60W 70W(Max 9000LM)

I V : Constant Voltage

C T : 3000K, 4000K

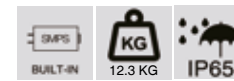

HEAD ONLY

DD



PL-70N

Pole luminaires

PL-70N은 고효율의 LED 보안등으로 대칭형의 배광을 가지고 있는 제품입니다.

제품은 낮에는 고전적인 디자인으로 심미성을 높여주고, 밤에는 신뢰성 있는 빛을 제공합니다.

제품의 배광 및 빛의 통일성의 측면을 살펴볼 때 공원, 주거지, 오피스 등의 공간에 적합한 제품입니다.

PL-70N is cost-efficient LED pole luminaires with symmetrical flat beam light distribution.

The products' appearance accentuates urban design by day while at night it creates a reliable light environment.

A luminaire concept whose light distribution, uniformity of light and energy efficiency are ideal for the illumination of park, residential streets, parking spaces and traffic-calmed areas.

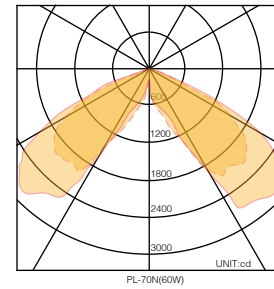

LED Pole luminaires

제품의 바디는 다이캐스팅알루미늄으로 제작되었습니다.
제품 2단 폴은 용융도금 스틸로 제작되었습니다.
강화유리 적용

Die-casting aluminium body, super white tempered glass
Optics with PC lens
surface anti-ultraviolet pure polyester powder painting

BODY : Aluminium die-casting
SIZE : 475 x 475 x H4,000(Optional)
CRI : ≤80
Lamp : LED 60W / 75W
I V : Constant Voltage
C T : 3000K, 4000K



HEAD ONLY

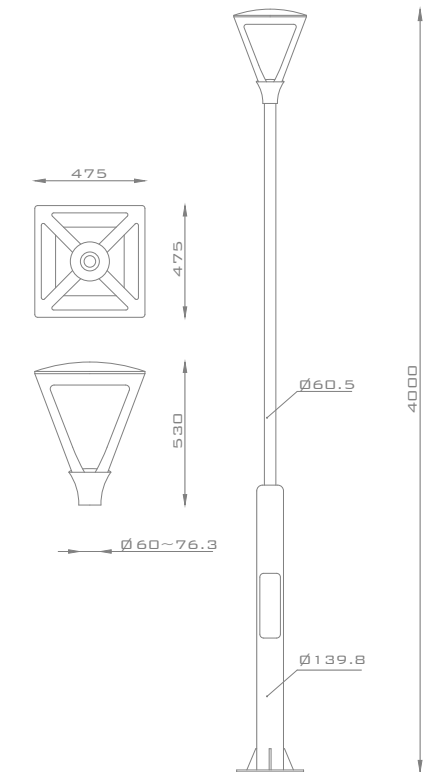
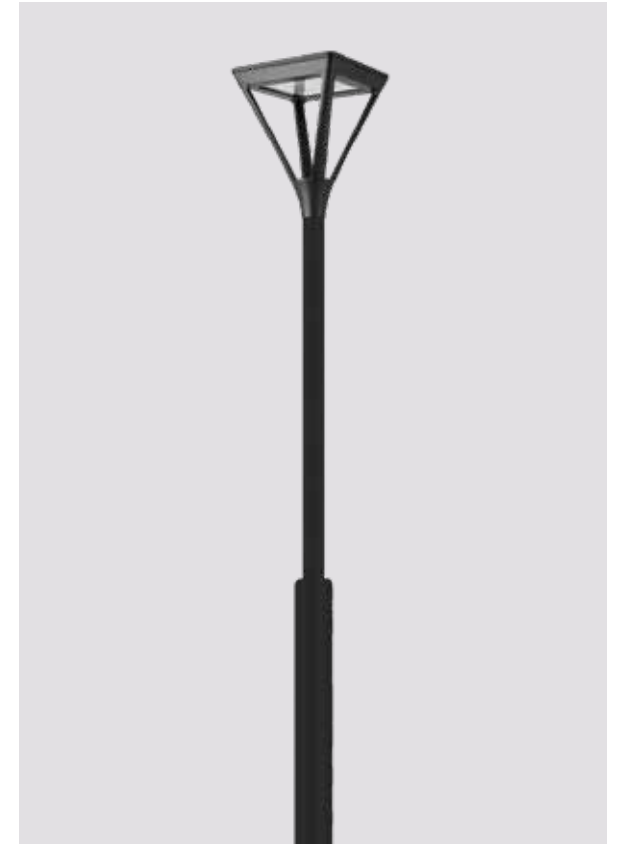

PL-190B

Pole luminaires

PL-190B은 고효율의 LED 보안등으로 대칭형의 배광을 가지고 있는 제품입니다.

제품은 낮에는 모던한 디자인으로 심미성을 높여주고, 밤에는 신뢰성 있는 빛을 제공합니다.

제품의 배광 및 빛의 통일성의 측면을 살펴볼 때 공원, 주거지, 오피스 등의 공간에 적합한 제품입니다.

PL-190B is cost-efficient LED pole luminaires with symmetrical flat beam light distribution.

The products' appearance accentuates urban design by day while at night it creates a reliable light environment.

A luminaire concept whose light distribution, uniformity of light and energy efficiency are ideal for the illumination of park, residential streets, parking spaces and traffic-calmed areas.

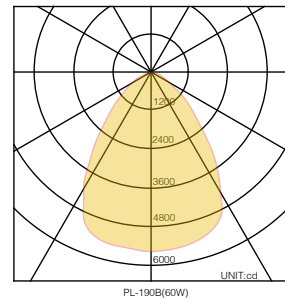

LED Pole luminaires

제품의 바디는 다이캐스팅알루미늄으로 제작되었습니다.

제품 2단 폴은 용융도금 스틸로 제작되었습니다.

강화유리적용

Die-casting aluminium body, super white tempered glass

Optics with PC lens

surface anti-ultraviolet pure polyester powder painting

Installation pipe diameter: Φ 60

BODY : Aluminium die-casting

SIZE : 475 x 475 x H4,000(Optional)

CRI : ≤ 80

Lamp : LED 40W / 60W(5600LM-8400LM)

I V : Constant Voltage

C T : 3000K, 4000K

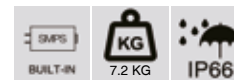

HEAD ONLY

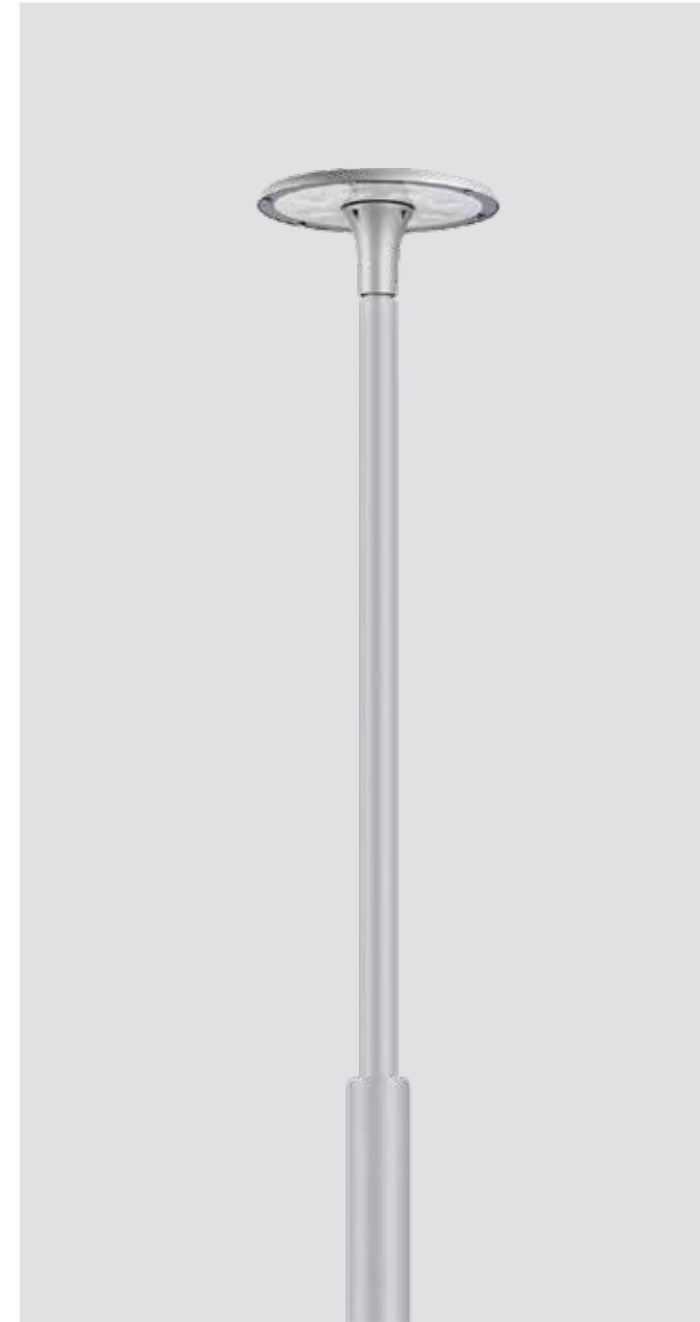



광화문, 지중조명 및 현판조명, Gwanghwa-mun, Seoul
적용제품: Nautilus-SQ, FLEX



광화문, 지중조명 및 현판조명, Gwanghwa-mun, Seoul

적용제품: Nautilus-SQ, FLEX



청주시 공원, Park in Cheonju-si
적용제품: PLM40

수원시 공원, Park in Suwon-si
적용제품: Deckcap-light

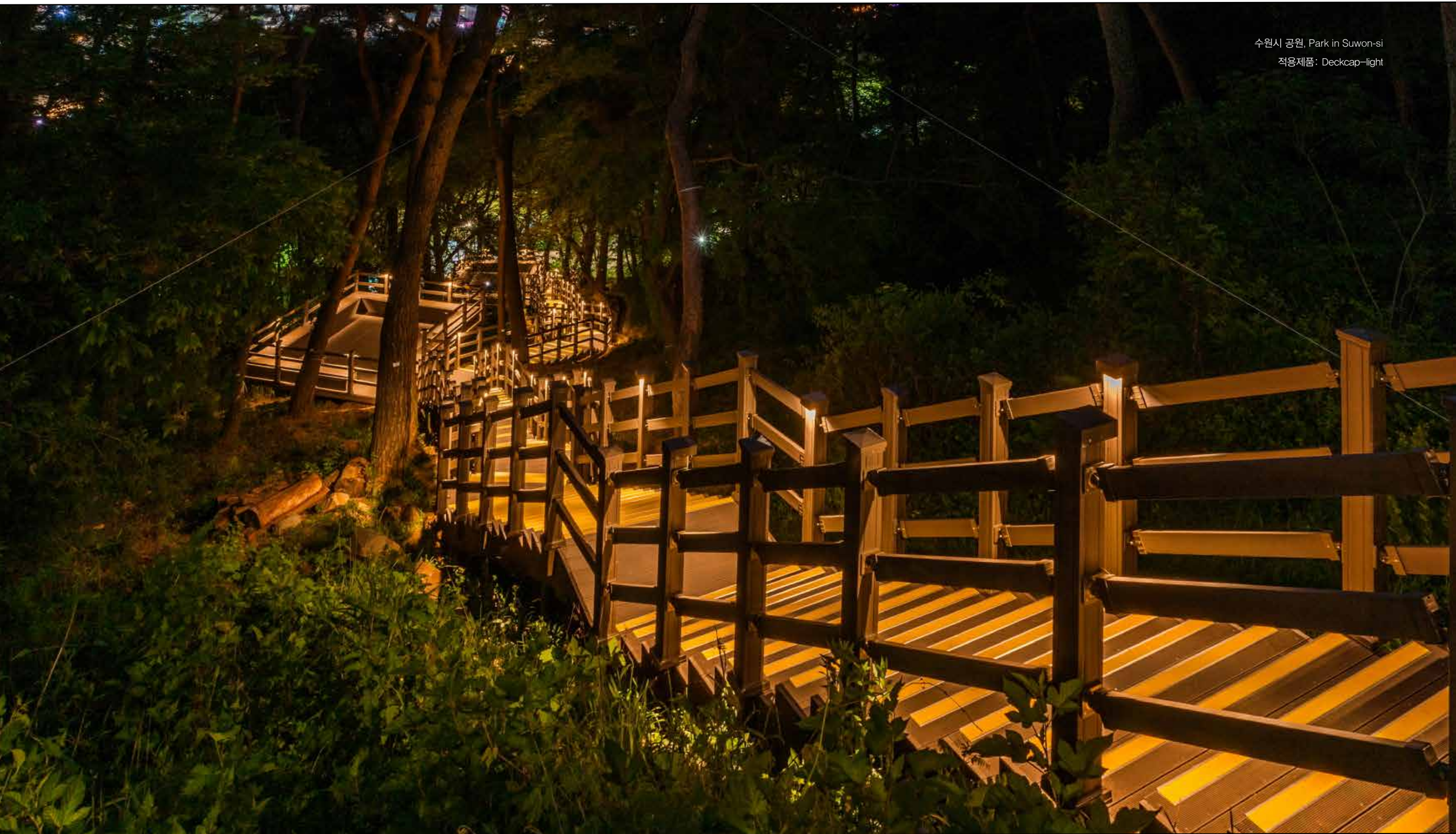

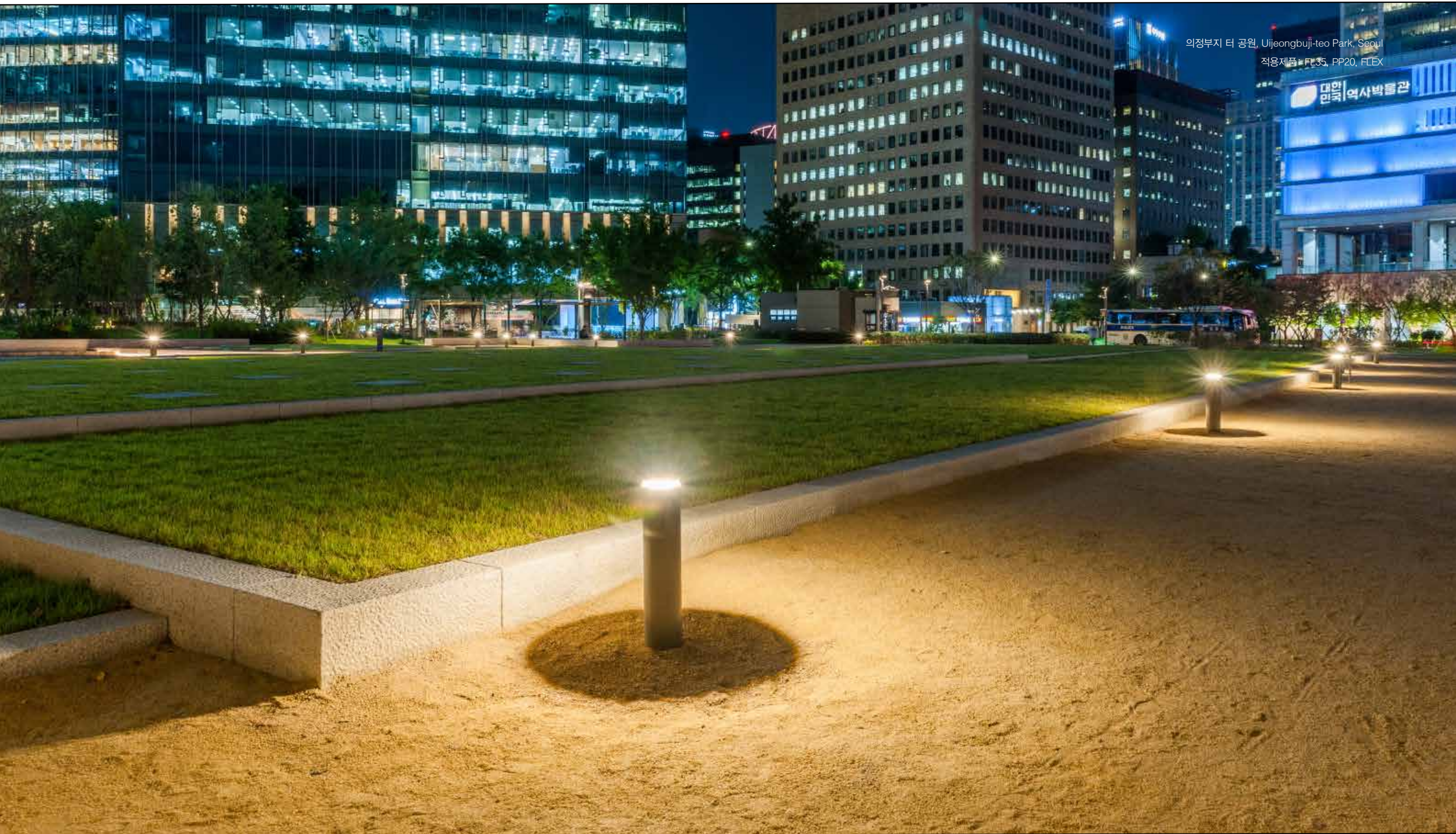

의정부지 터 공원, Uijeongbuji-teo Park, Seoul
적용제품 : FL35, PP20, FLEX







철원시, 노동당사, Workers' Party HQ, Cheorwon
적용제품: Nautilus-SQ



공세리 성당, 아산시, Catholic church, Asan.si
적용제품: Nautilus-SQ, Canon

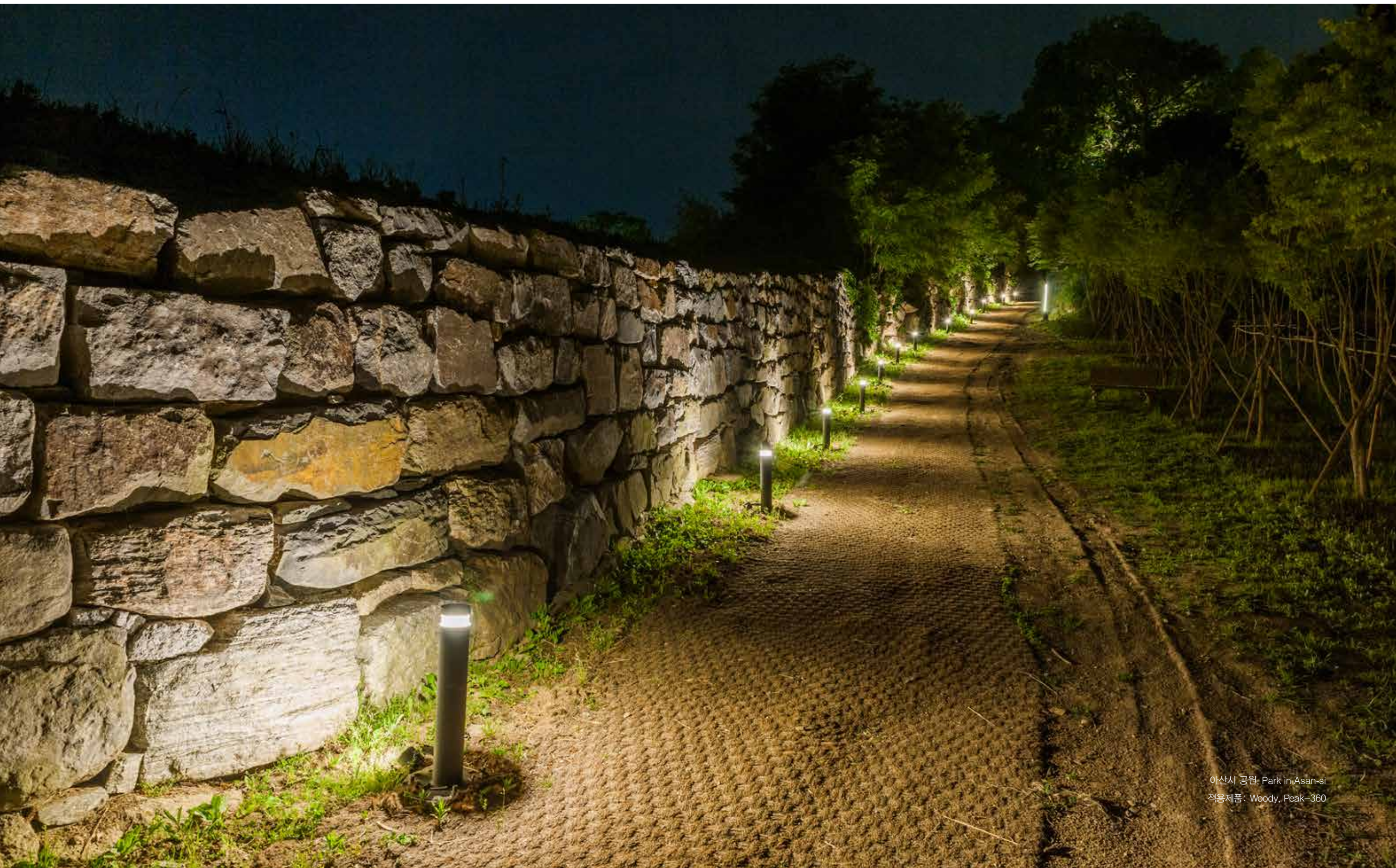

아산시 공원, Park in Asan-si
적용제품: Woody, Peak-360

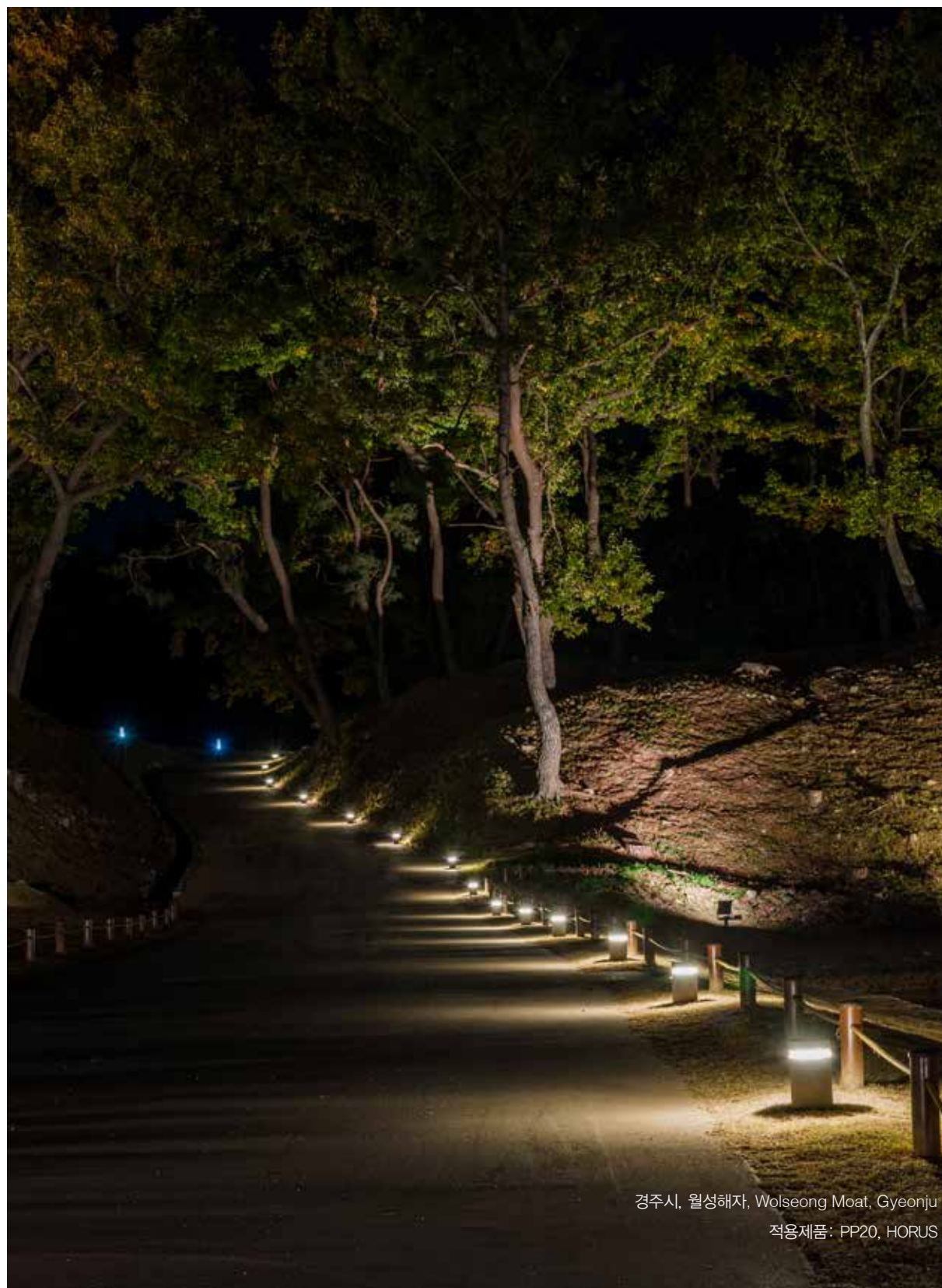

경주시, 월성해자, Walseong Moat, Gyeongju
적용제품: PP20, HORUS



경주시, 불국속박단지, Bulguk Residence complex, Gyeongju
적용제품: Custommade



오릉돌담길 Ohreung street, Gyeongju-si
적용제품: Custommade



경주시, 감은사지, Gameunsa Temple Site, Gyeongju
적용제품: Ray, Horus, Winkle50



경주시, 감은사지, Gameunsa Temple Site, Gyeongju
적용제품: Ray, Horus, Wrinkle50



경주시, 황룡사지, Hwangnyonsa Temple Site, Gyeongju
적용제품: Daon, Hexagon-s



경주시, 동궁과 월지, Donggung Palace and Wolji Pond, Gyeongju
적용제품: Nautilus-SQ



경주시, 동궁과 월지, Donggung Palace and Wolji Pond, Gyeongju
적용제품: Nautilus-SQ



경주시, 월성해자, Walseong Moat, Gyeongju
적용제품: PP20, HORUS, PEAK360



경주시, 월성해자, Wolseong Moat, Gyeongju
적용제품: STEM

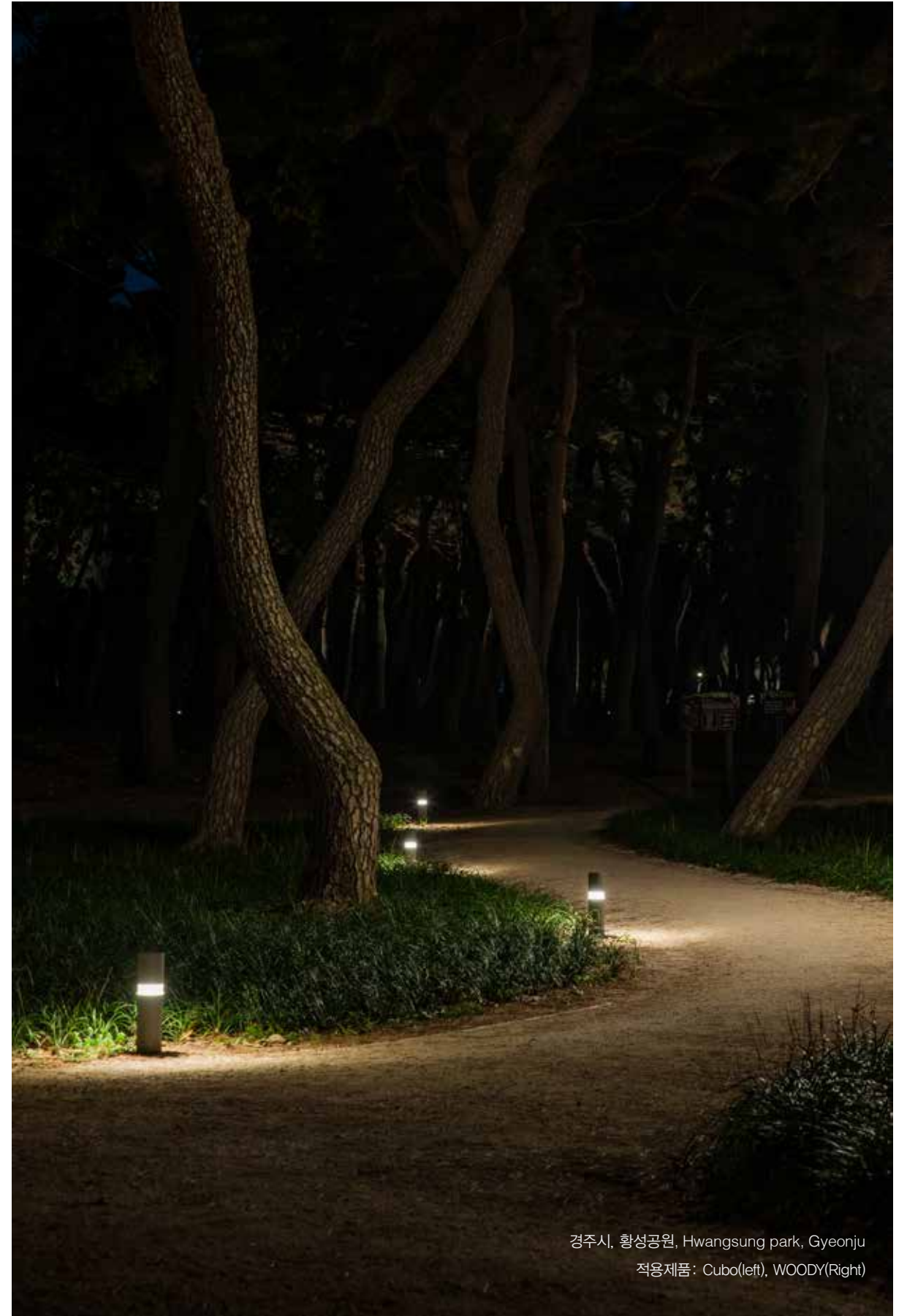
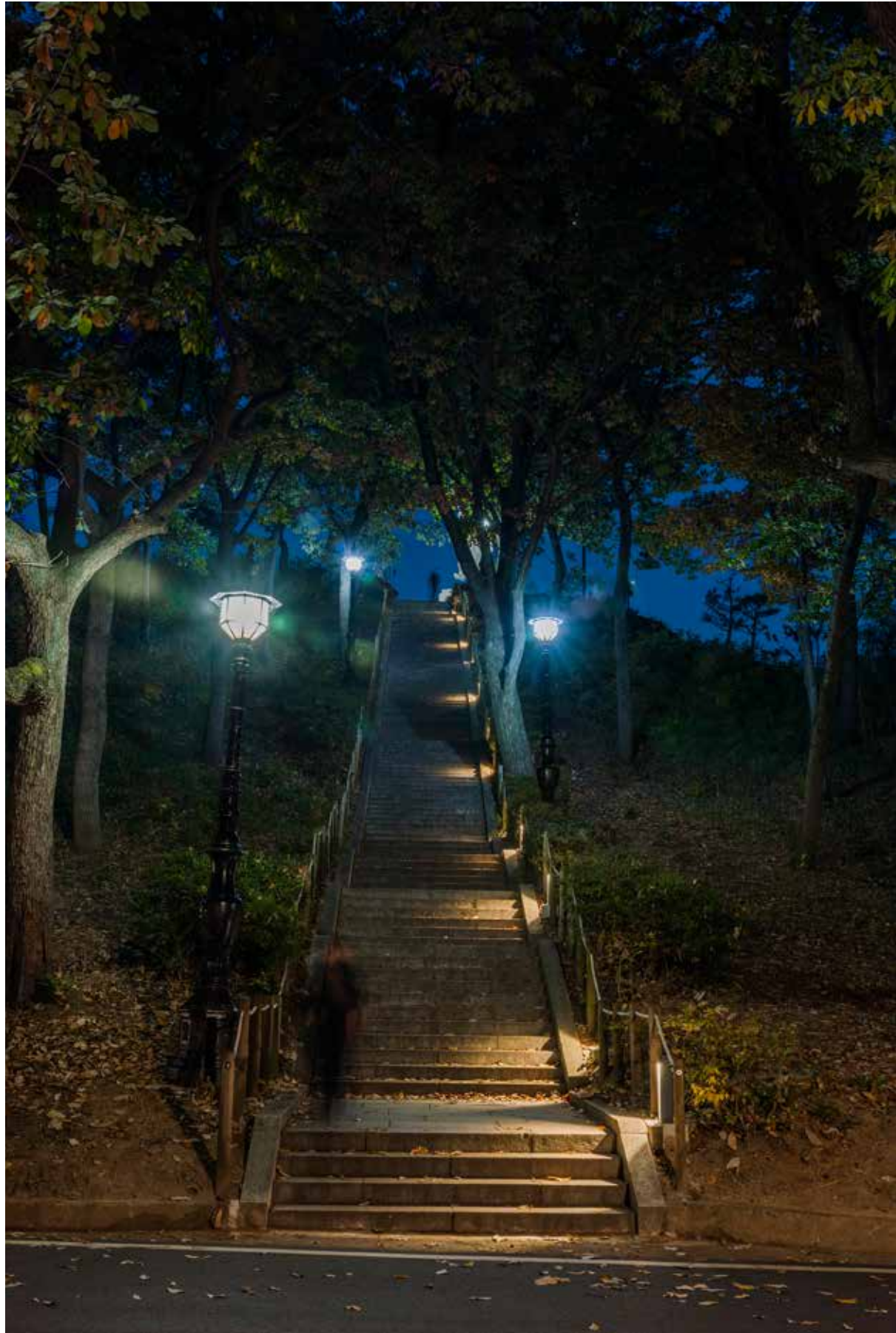

경주시, 황성공원, Hwangsung park, Gyeongju
적용제품: Cubo(left), WOODY(Right)

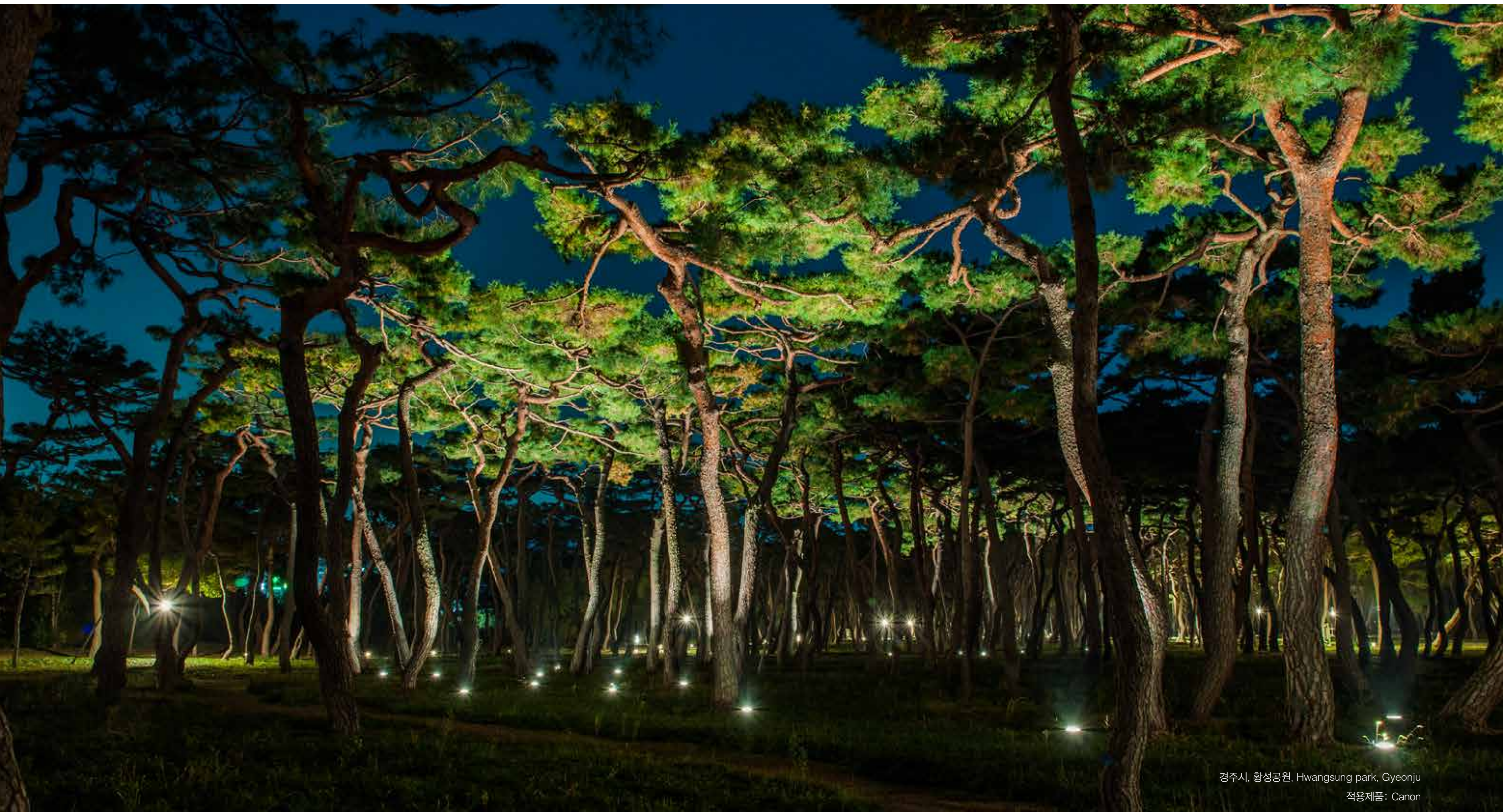

경주시, 황성공원, Hwangsung park, Gyeongju
적용제품: Canon

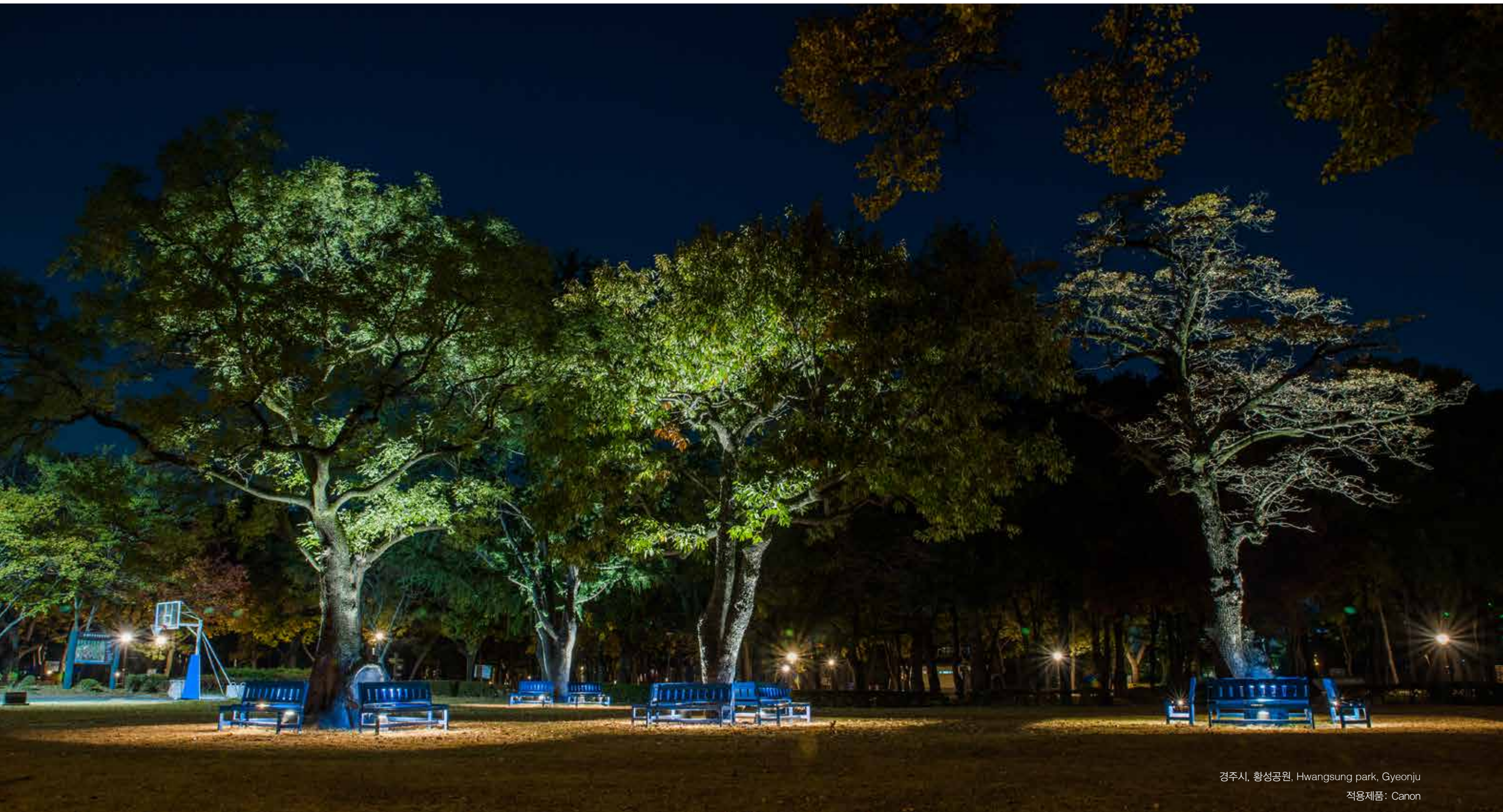

경주시, 황성공원, Hwangsung park, Gyeongju
적용제품: Canon

논산시, 논산시청, City hall, Nonsan-si
적용제품: Horus





보도교, 대구광역시, Pedestrian bridge, Daegu
적용제품: Wrinkle50, Vision

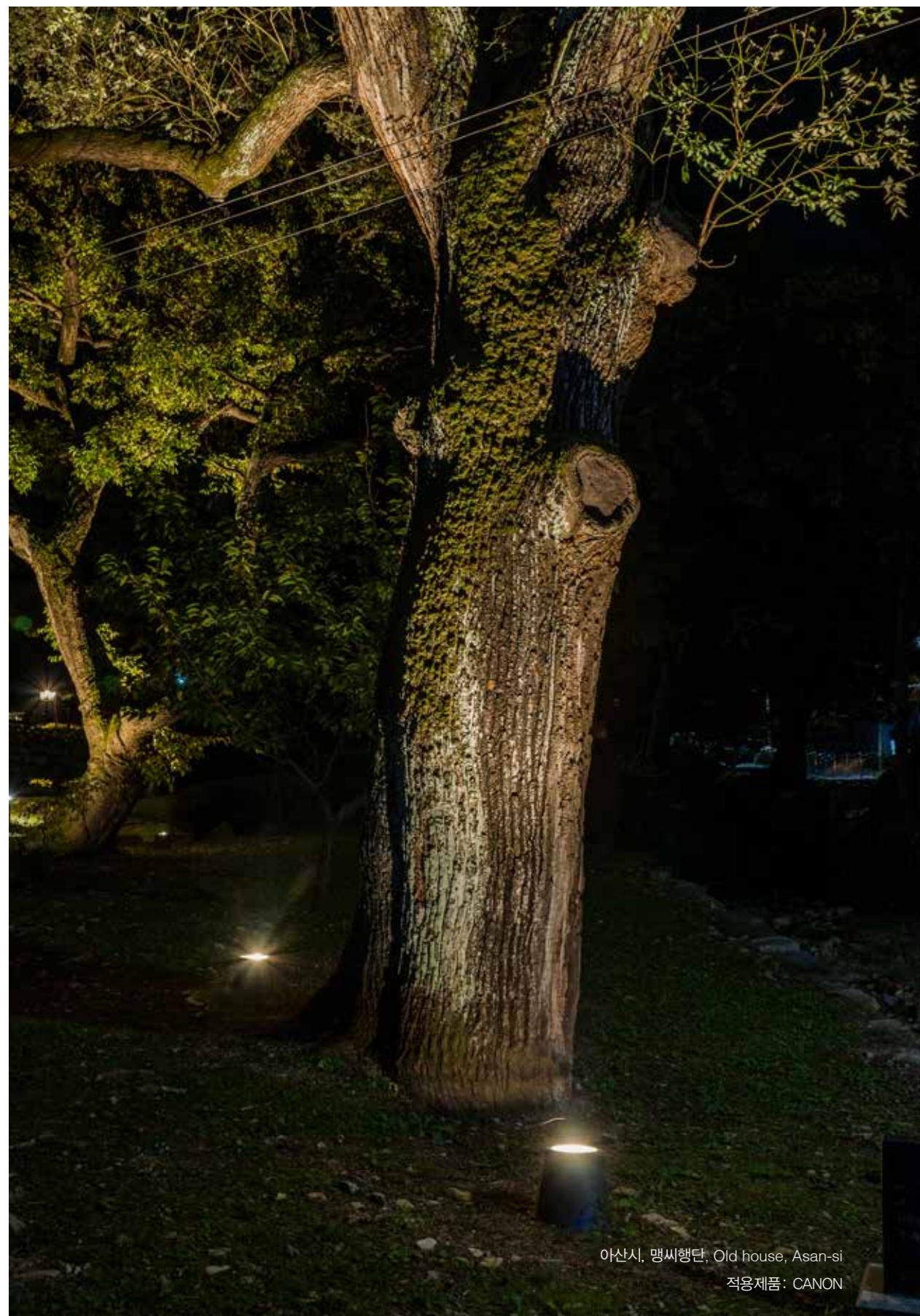

아산시, 맹씨행단, Old house, Asan-si
적용제품: CANON



식물원, 부천시, Botanic garden, Bucheon-si
적용제품: Nautilus-SQ(RGBW)

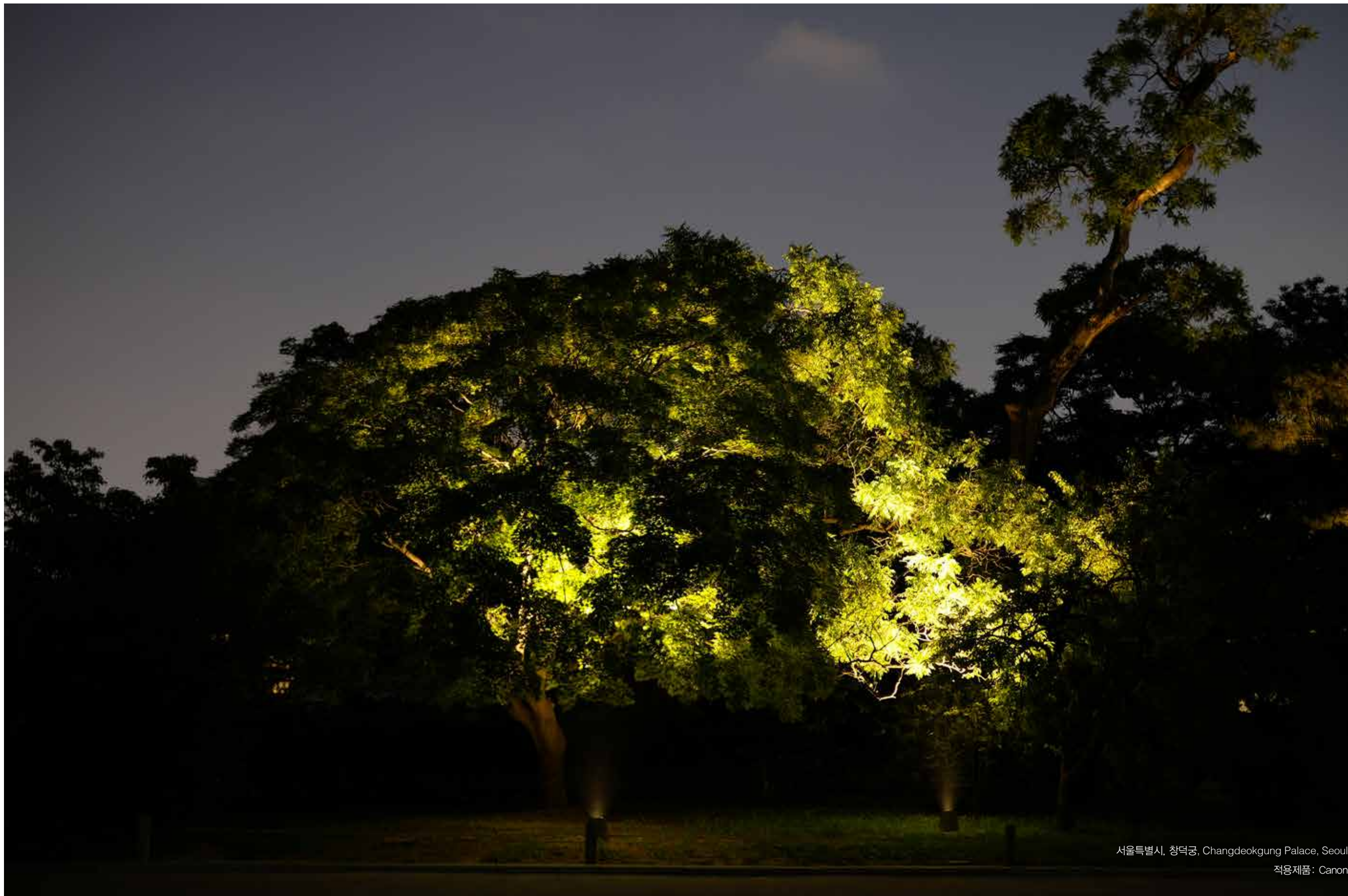

서울특별시, 창덕궁, Changdeokgung Palace, Seoul
적용제품: Canon



송도 아파트 현장, Apartment in Songdo
적용제품: SL-40



송도 아파트현장, Apartment Songdo
적용제품: SL-40

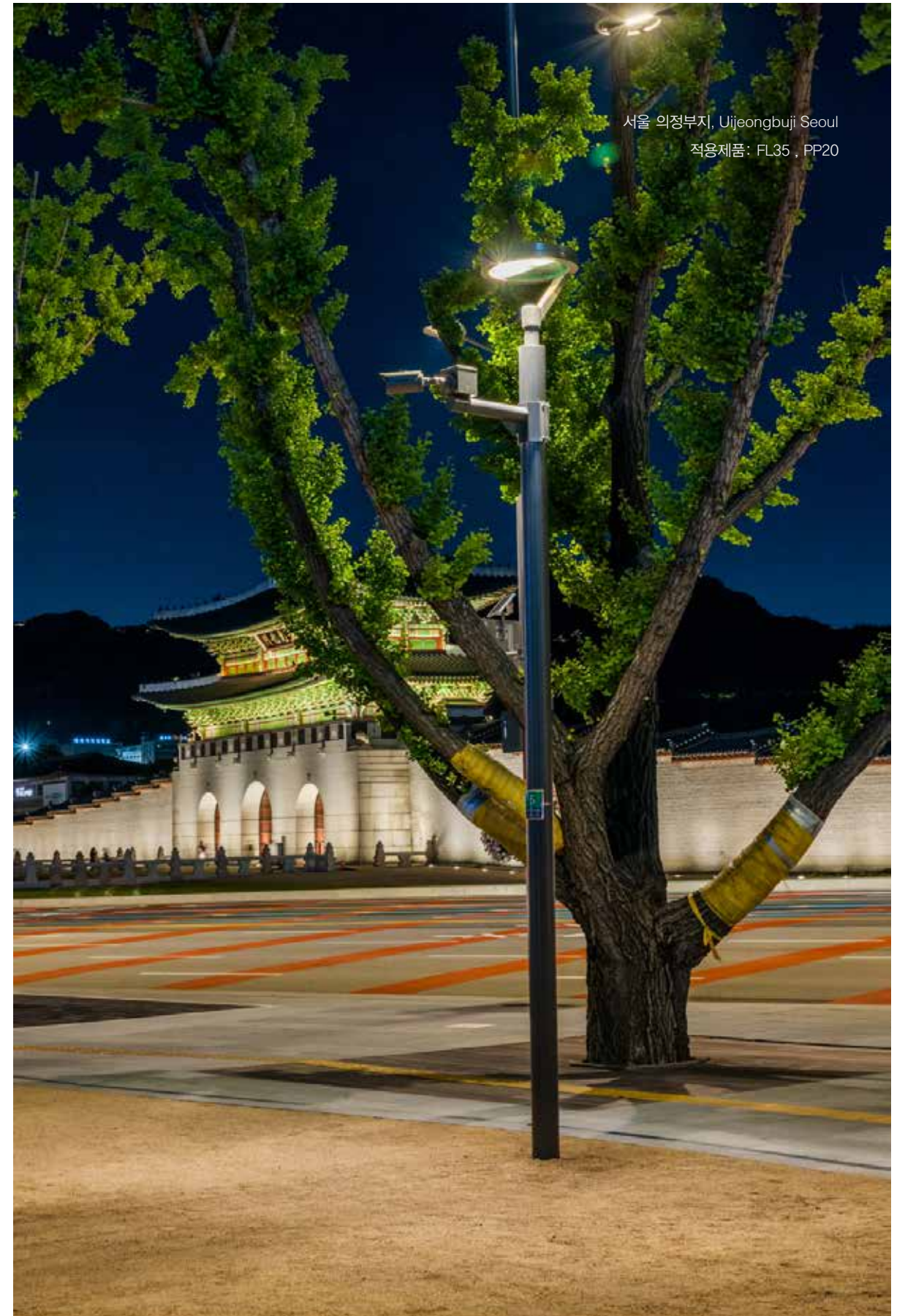

서울 의정부지, Uijeongbuji Seoul
적용제품: FL35, PP20

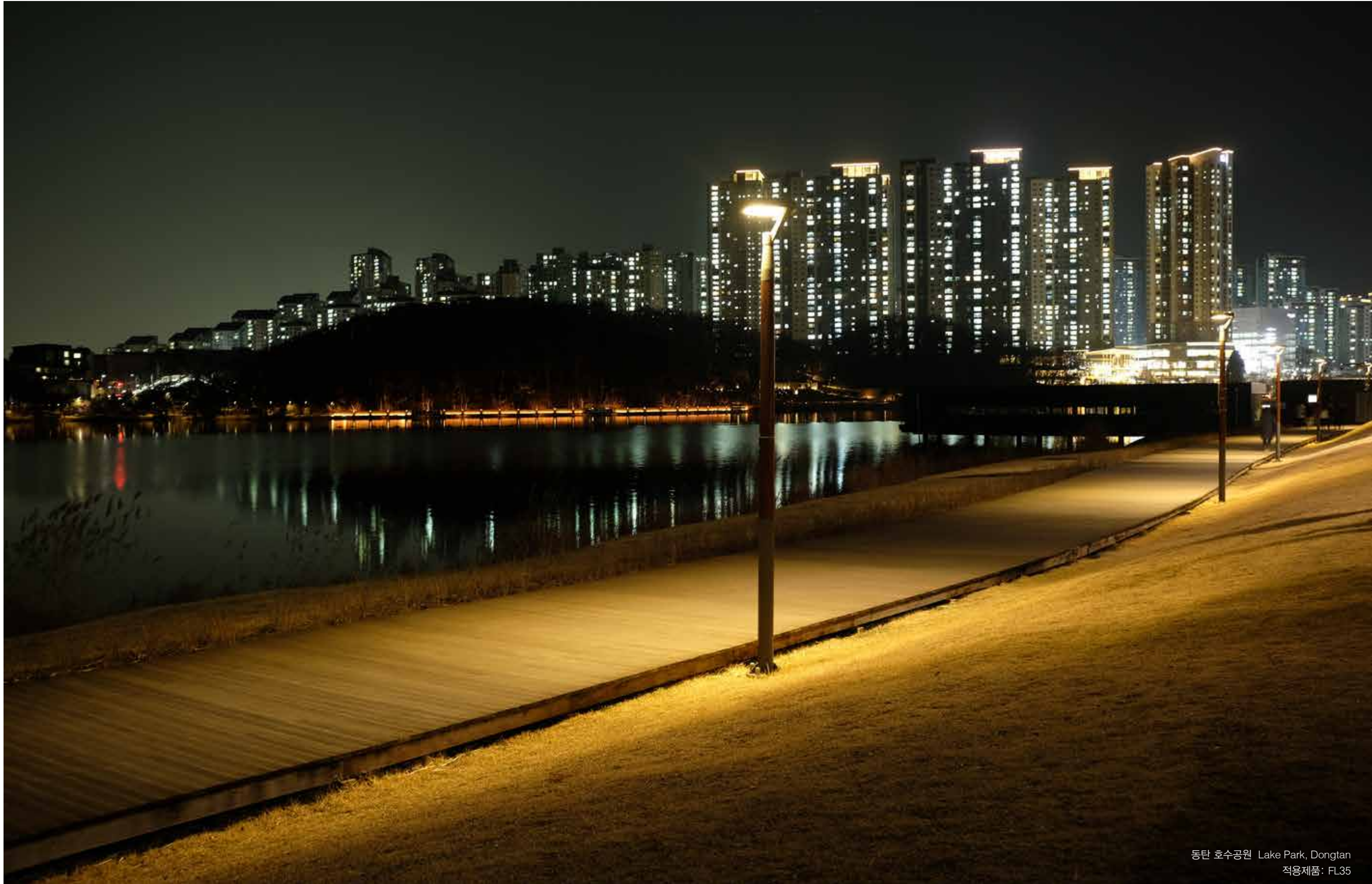

동탄 호수공원 Lake Park, Dongtan
적용제품: FL35



인천 문화예술회관 Culture & Arts Center, Incheon
적용제품: VISION



서울특별시, 창덕궁 Changdeokgung Palace, Seoul
적용제품: NAUTILUS-SQ



전라남도 영암군, 영보정 Yeongbojeong Pavilion, Yeongam
적용제품: NAUTILUS-SQ



경상북도 경주시, 금장대 Geumjang, Gyeongju
적용제품: FLEX





서울 광진숲나루 자라나는 숲 Forest Place, Gwangjin, Seoul
적용제품: PP20, Nautilus-BT, Custommade



원주 강원감영 Wonju old government office, Wonju
적용제품: Nautilus-BT, WOODY

COLORS

By Products
customize color available



ECO-Dark Grey



ECO-Dark Brown



ECO-Silver(POLE)

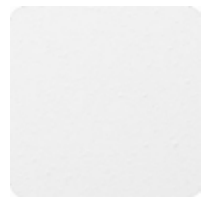

ECO-White



ECO-STs Hairline

On Demand*

에코브릿지 본사 및 공장

경기도 부천시 오정구 성곡로 30
30 Sunggok-ro Bucheon-si
Gyeonggi-do South Korea

ECOBIDGE

Web : www.ecobridgelighting.com

Phone : 032-671-1141

Fax : 032-671-1441

E-Mail : ecobridge11@gmail.com(영업)

ecobridge13@gmail.com(설계,개발)

